

Science and Technology Create Perfection

Installation and Operating Manual

SR868C8/SR868C8Q **SOLAR CONTROLLER**

For Split Pressurized Hot Water System



Read the instruction carefully please before operation!

Contents

1. Safety information	4
1.1 Installation and commissioning	4
1.2 About this manual	4
1.3 Liability waiver	4
1.4 Important remark.....	5
1.5 Description of symbols	5
1.6 Description of operation button	6
2. Installation	7
2.1 Installing the display unit of controller	7
2.2 Installing the control unit	7
2.3 Preparing before wire connection	8
2.4 Power connection.....	8
2.5 Terminal connection	9
3. Commissioning	11
3.1 Set time/week	11
3.2 Menu structure.....	12
3.3 Menu description	13
3.4 System description.....	14
4. Function operation and parameter setup (user grade).....	16
4.1 Main menu - THET timing heating	16
5.function operation and parameter setup (engineer grade)	20
5.1 Access main menu.....	20
5.2 Access submenu.....	20
5.3 Main menu DT O & DT F Temperature difference function.....	20
5.4 TEMP Temperature main menu.....	21
5.4.1 EM Emergency collector temperature(Emergency switch-off function).....	22
5.4.2 CMX Maximum limited collector temperature (collector cooling function)	24
5.4.3 CMN low temperature protection of collector	25

5.4.4 CFR frost protection of collector	25
4.4.5 SMX Maximum temperature of tank.....	26
5.4.6 REC Tank re-cooling function	27
5.4.7 C- F Celsius and Fahrenheit temperature transferring	27
5.5 FUN Auxiliary function	28
5.5.1 DVWG Anti-Legionella function	29
5.5.2 CIRC Temperature controlled hot water circulation pump	29
5.5.3 nMIN Solar circuit pump speed adjusting (RPM speed controlling)	30
5.5.3.1 DTS Standard temperature difference (for circuit pump's speed adjusting)	31
5.5.3.2 RIS Temperature increase rate (for circuit pump speed adjusting)	32
5.5.4 OHQM Thermal energy measuring	32
5.5.4.1 FMAX Flow rate	33
5.5.4.2 MEDT Type of heat transfer liquid	34
5.5.4.3 MED% Concentration of heat transfer liquid.....	34
5.5.5 INTV Pump interval function.....	35
5.5.5.1 tSTP Pump interval- time.....	36
5.5.5.2 tRUN Pump running time.....	36
5.5.6 BYPA High temperature by-pass function (tank temperature automatically adjusting)	37
5.6 HND Manual mode	38
5.7 PASS Password setting	39
5.8 LOAD Recovery factory setting	40
5.9 ON/OFF button.....	40
5.10 Holiday function.....	40
5.11 Manual heating.....	41
5.12 Temperature query function	42
6. Protection function	42
6.1. Memory protection	42

6.2 Screen protection	42
7. Trouble shooting.....	43
7.1 Trouble protection	43
7.2 Trouble checking.....	44
8. Quality Guarantee	46
9. Technical data	46
10. Delivery scope	47
11. Accessories.....	48

1. Safety information

1.1 Installation and commissioning

- When laying cables, please ensure that no damage occurs to any of the constructional fire safety measures presented in the building.
- The controller must not be installed in rooms where easily inflammable gas mixtures are present or may occur.
- The permissible environmental conditions can't be exceeded at the site of installation.
- Before connecting the device, make sure that the energy supply matches the specifications that controller requires.
- All devices connected to the controller must conform to the technical specifications of the controller.
- All operations on an open regulator are only to be conducted cleared from the power supply. All safety regulations for working on the power supply are valid.
- Connecting and /or all operations that require opening the regulator (e.g. changing the fuse) are only to be conducted by specialists.

1.2 About this manual

This manual describes the installation, function and operation of a solar thermal controller.

When installing the remaining components e.g. the solar collectors, pump assemblies and the storage unit, are sure to observe the appropriate installation instructions provided by each manufacturer. Only trained professional personnel may only perform installation, electrical connection, commissioning and maintenance of the device. The professional personnel must be familiar with this manual and follow the instructions contained herein.

1.3 Liability waiver

The manufacturer cannot monitor the compliance with these instructions or the circumstances and methods used for installation, operation, utilization and maintenance of this controller. Improper installation can cause damages to material and persons. This is the reason why we do not take over responsibility and liability for losses, damages or cost that might arise due to improper installation, operation or wrong utilization and maintenance or that occurs in some connection with the

aforementioned. Moreover we do not take over liability for patent infringements or infringements – occurring in connection with the use of this controller- on third parties rights. The manufacturer preserves the right to put changes to product, technical data or installation and operation instructions without prior notice. As soon as it becomes evident that safe operation is no longer possible (e.g. visible damage). Please immediately take the device out of operation. Note: ensure that the device cannot be accidentally placed into operation.

1.4 Important remark

We have carefully checked the text and pictures of this manual and provided the best of our knowledge and ideas, however inevitable errors may exist. Please note that we can not guarantee that this manual is given in the integrity of image and text, they are just some examples, and they apply only to our own system. Incorrect, incomplete and erroneous information and the resulting damage we do not take responsibility.

1.5 Description of symbols



Safety instruction:

The safety instructions in the manual are marked with a warning triangle. They indicate measures, which can lead to personal injury and safety risks.

Operation steps: small triangle “▶” is used to indicate operation step.

Notes: Contains important information about operation or function.

1.6 Description of operation button

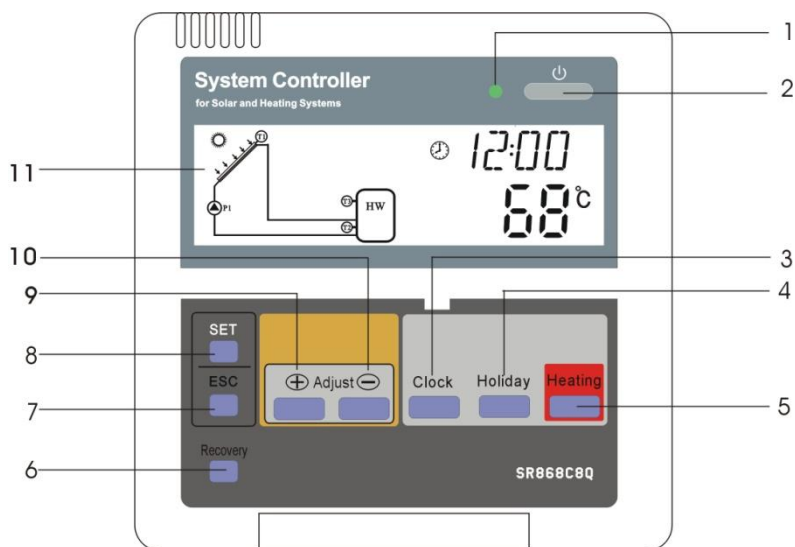

No.	Button description
1	Power indicating light
2	“On/off” button
3	“Clock” button
4	“Holiday” button(SR868C8 have no such function)
5	“Heating”- manual heating button
6	“Recovery” button
7	“ESC”, exit program setup
8	“SET” confirm button
9	“+” Parameter adjust button
10	“-” Parameter adjust button
11	LCD display screen

2. Installation

Controller can only be installed indoors, far away from dangerous place and away from the electromagnetic field. Controller should be equipped with an additional plug, which should have minimum 3mm distance between the pole of the plug or effective compliance with the provisions of the installation. For example, switch or fuse, please note that it should be separated between the wires, and use AC power.

2.1 Installing the display unit of controller

- ▶ Take away the back cover plate of display unit by screwdriver, see picture ①
- ▶ Fix the back cover plate on wall; see picture ②, (**Note:** don't drill hole on the cover plate)
- ▶ Insert display into groove of back cover ①②, installing the display unit on the back cover plate see picture ③



Picture 1

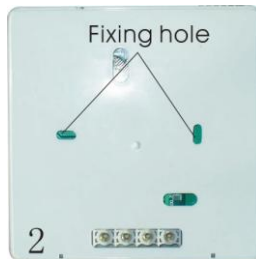

Picture 2

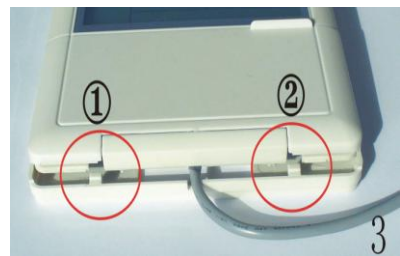

Picture 3

2.2 Installing the control unit



Note: the controller can only be installed in an area having an adequate level of protection.

Fixing the hang-panel of controller

- ▶ Choose a suitable site
- ▶ Mark the position of hole
- ▶ Drill the fixing hole, insert the expansion screw
- ▶ Fix the hanging plate by using screw
- ▶ Press the control unit on the hanging plate

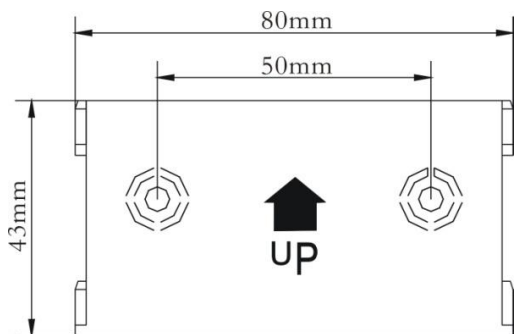

2.3 Preparing before wire connection



Please switch-off the power net before opening the controller cover, and note the regulation of local electricity supply.

Open/ close the cover of terminal

- ▶ Loosen the screw ①②, move cover upwards and take away the cover
- ▶ Close the cover: downwards close cover
- ▶ fix cover by using screw ①②.

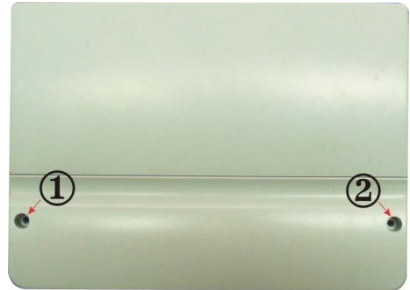

2.4 Power connection

Power can only be switched on when the house of controller is closed, an installer must make sure that the IP protection class of the controller is not damaged during installation.

Depending on the type of installation, the cables may enter the device through the rear hole of the case ④ or the lower side hole of the case ⑤

Cable come from the rear ④: remove the plastic flaps from the rear side of the case using an appropriate tool.

Cable come from the below ⑤: cut the left and right plastic flaps using an appropriate tool (e.g. knife) and break them out of the case.

Notes: the flexible wire must be fastened on the case using the clamps provided

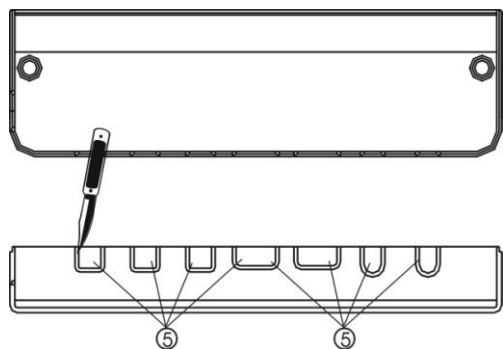
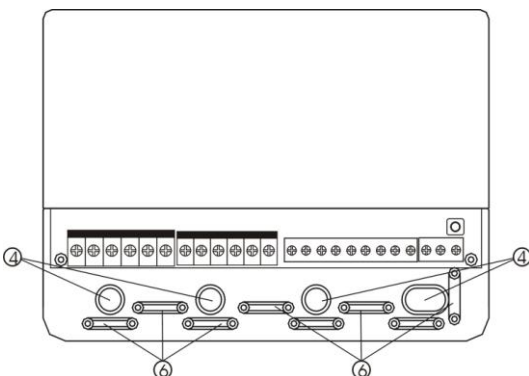

2.5 Terminal connection



Before to open the terminal, please be sure to switch-off the power supplier and pay attention to the local electricity supply rules.

● Terminal layout

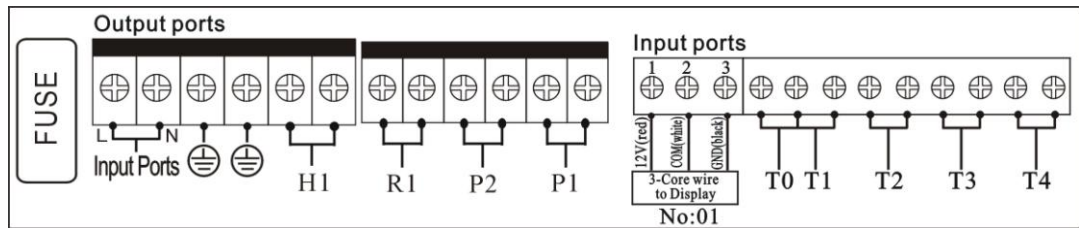

- FUSE:2A/250V

● Power connection

Power connection terminal is: Input ports

Ground line terminal is GND

● Display connection

Port 1: connect red wire (+12V) Port 2: connect white wire (COM)

Port 3: connect black wire (GND)

Note: please lead wire into indoors, and fix the cable outdoors.

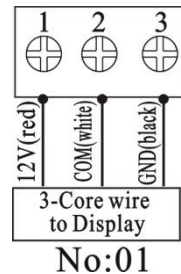

● Sensor input ports

Input sensor ports T0, T1: for Pt1000 sensors, used for measuring the temperature of collector and measuring the heat output.

Input sensor ports T2, T3, and T4: for NTC10K, B=3950 sensors, used for measuring the temperature of tank and pipe.

● Advice regarding the installation of temperature sensors:

Only original factory equipped Pt1000 temperature sensors are approved for use with the collector, it is equipped with 1.5meter silicon cable and suitable for all weather conditions, the temperature sensor and cable are temperature resistant up to 280 °C,

not necessary to distinguish the positive and negative polarity of the sensor connection.

Only original factory equipped NTC10K,B=3950 temperature sensors are approved for use with tank and pipe, it is equipped with 1.5meter PVC cable, and they are temperature resistant up to 105°C, not necessary to distinguish the positive and negative polarity of the sensor connection.

All sensor cables carry low voltage, and to avoid inductive effects, must not be laid close to 230 volt or 400-volt cables (minimum separation of 100mm)

If external inductive effects are existed, e.g. from heavy current cables, overhead train cables, transformer substations, radio and television devices, amateur radio stations, microwave devices etc, then the cables to the sensors must be adequately shielded.

Sensor cables may be extended to a maximum length of ca. 100 meter, when cable's length is up to 50m, and then 0.75mm² cable should be used. When cable's length is up to 100m, and then 1.5mm² cable should be used.

- **Output ports**

Output P1: For solar circuit pump, semiconductor relay (SCR relay), also suitable for RMP control, max. switching current 1A,

Output P2: for hot water circuit pump, electromagnetic relay, and max. switching current 3.5A,

P2 ports are always open,

Output R1: for by-pass circuit pump or valve, electromagnetic relay, max. switching current 3.5A, R1 ports are always open,

Output H1: for back-up electrical heater, electromagnetic relay, and max. switching current 10A, H1 connection ports are always open.

3. Commissioning



Connect the sensors, pumps or switching valves to the controller before you connect the power supply!

After switching on power to the controller, firstly it will ask for to set the time, password and parameters of system.

3.1 Set time/week

▶ Press “Clock” button, time displays on screen, hour selection area “00” blinks on display screen.

▶ Press “+”“-” button to set hour of clock

▶ Press “Clock” button again, minute area “00” blinks

▶ Press “+”“-” button to set minute of clock.

▶ Press “Clock” again, week area “MO” blinks

▶ Press “+”“-” button to set week.

▶ Press “ESC” button

to exit set program, or wait for 20 seconds to exit program automatically.

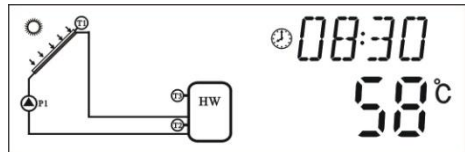

Code	Week day
MO	Monday
TU	Tuesday
WE	Wednesday
TH	Thursday
FR	Friday
SA	Saturday
SU	Sunday

3.2 Menu structure

Menu of controller SR868C8Q

Menu of controller SR868C8

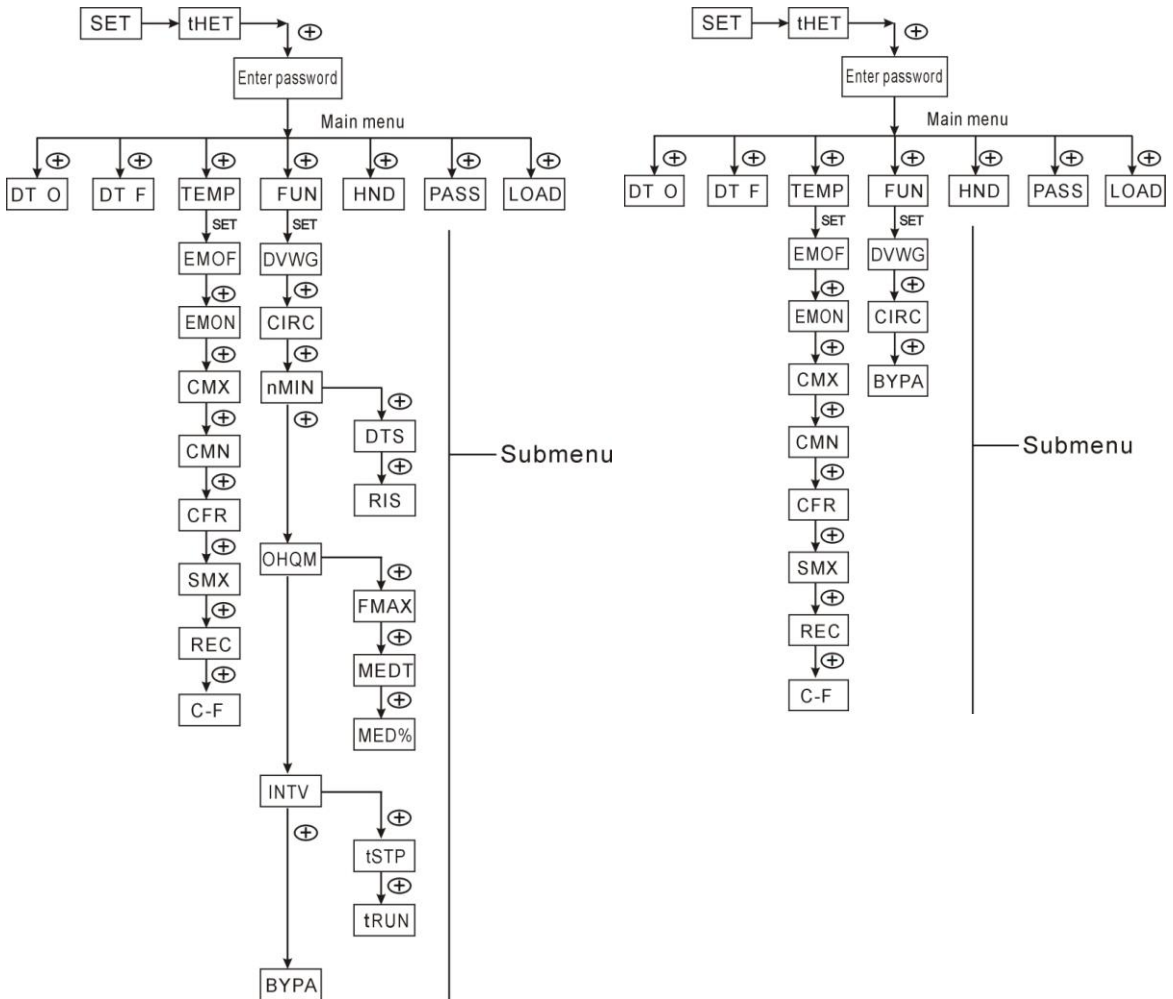

Submenu:

Through submenu, customer can set the parameter as desired value, please check it carefully.

3.3 Menu description

Code Mainmenu	Code Submenu	Code Submenu	Menu Description	Remark
THET			Timing heating	
PWD 0000			Input password	
DT O			Switch-on temperature difference	
DT F			Switch-off temperature difference	
TEMP			Temperature	
	EMOF		Collector maximum switch-off temperature	
	EMON		Collector maximum switch-on temperature	
	CMX		Maximum temperature of collector (Collector cooling function)	
	CMN		Low temperature protection of collector	
	CFR		Frost protection of collector	
	SMX		Maximum temperature of tank	
	REC		Tank re-cooling function	
	C-F		Celsius and Fahrenheit temperature transferring	
FUN			Auxiliary function	
	DVWG		Anti legionnaires' function	
	CIRC		Temperature controlled hot water circulation pump	
	nMIN		Speed controlling of circulation pump (RPM pump controlling)	Only available on controller SR868C8Q

		DTS	Standard temperature difference (for circulation pump speed adjust)
		RIS	Increase scale (circulation pump speed adjusting parameter set)
	OHQM		Thermal energy measuring
		FMAX	Flow rate
		MEDT	Type of heat transfer liquid
		MED%	Concentration of heat transfer liquid
	INTV		Pump interval function
		tSTP	Pump interval time
		tRUN	Pump running time
	BYPA		By pass (high temperature)
HDN			Manual controlling
PASS			Password set
LOAD			Recovery to factory set

3.4 System description

1 collector array – 1 storage tank – 1 pump and auxiliary heating

Description:

The solar circuit pump (P1) is switched on as soon as the switch-on temperature difference (ΔT_{on}) between the collector array (T1) and the storage tank (T2) is reached. If the temperature difference between the collector array (T1) and storage tank (T2) drops below the switch-off temperature difference (ΔT_{off}), or the temperature of storage tank (T3) reaches the preset maximum storage temperature, then the solar circuit pump (P1) is switched off.

Back-up heating by auxiliary boiler (detailed see paragraph 4.4):

Within the preset time section of back-up heating, if the temperature T3 is below the switch-on temperature, then the circulation pump (H1) of back-up heating is triggered, when T3 is heated to the switch-off temperature, circulation pump H1 of back-up heating is ceased.

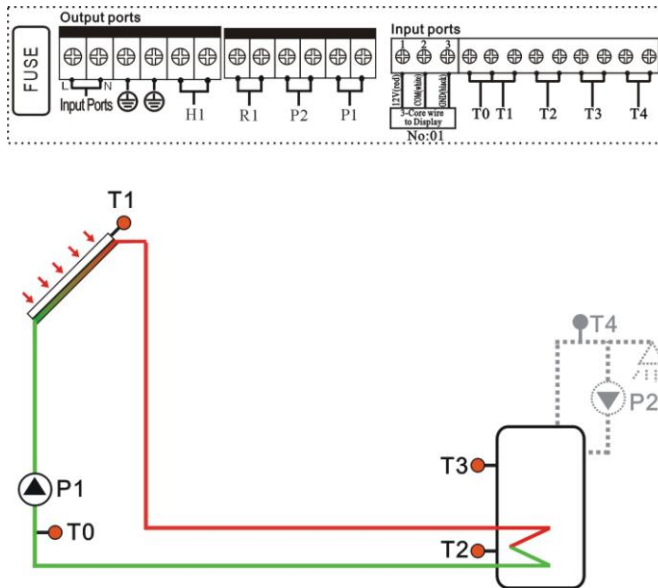

Note:

T3 is alternative sensor, when no sensor (T3) is installed in the top part of tank, controller will use the signal of sensor T2 automatically to control the auxiliary heating or the circulation pump.

T0: Temperature sensor for thermal energy measuring (optional sensor)

T1: Temperature sensor for collector array (PT1000)

T2: Temperature sensor in the bottom part of tank 1(NTC10K)

T3: Temperature sensor in the top part of tank (NTC10K,optional sensor)

T4: Temperature sensor on hot water circulation pipe (NTC10K,optional sensor)

P1: Solar circuit pump

P2: Hot water circuit pump (optional output)

R1: High temperature by-pass pump or valve (optional output)

H1: output for back-up electrical heater

4. Function operation and parameter setup (user grade)

4.1 Main menu - THET timing heating

Description:

Electrical heater, gas boiler or oil boiler can be integrated into solar system used as back-up of system, and they can be triggered automatically at preset time by preset temperature. Within a preset time section, when the temperature (T3) of top part of tank drops below the preset switching-on temperature of this function, back-up heating starts to work, when T3 rises up to the preset turning off temperature, back-up heating is stopped. Within 24 hours, three time sections can be set with this controller.

Factory set:

The first time section: back-up heating function starts at 4:00 and ends at 5:00 am.

Within this time section, switch-on temperature is 40°C, switch-off temperature is 45°C.

The second time section: from 10:00 to 10:00 am, it means there is no back-up heating in this time.

The third time section: back-up heating function starts at 17:00 and ends at 22:00 pm.

Within this time section, the switch-on temperature is 50°C, switch-off temperature is 55°C.

The switch-on temperature adjustable range: 10°C ~ (OFF-2 °C)

The switch-off temperature adjustable range: (ON+2 °C) ~ 80°C

If you want to shut off one timing heating, then you can set the turning on time and turning off time same value (for example, the second time section no this function, then you can set turning on/off time is 10:00 ~ 10:00)

When time is outside of the preset time section, back-up heating doesn't work automatically even when the tank temperature reaches the switch –on temperature of heating.

Note:

- When there is no sensor installed in the top part of tank (no T3 sensor), controller will take the signal of T2 (sensor in bottom of tank) automatically to control this function.

- The time in this controlled is 24 hours, when you set time section, the switch-off time of heating should be larger than switch-on time. For example: if you set the switch-on time of heating is at 17:00, but switch-off time of heating is 6:00, then this setting doesn't take effect, that means within this time section, heating function doesn't work. The correct set is like flowing: it should be divided into two time sections, one time section is from 17:00 to 23:59, the other time section is from 00:00 to 06:00.

Setup steps:

Under standby status, access main menu tHET

▶ Press "SET" button, access THET program to set parameter, "tH 1o 04:00" displays on screen, the switch-on time and temperature for first time section of heating function can be set

▶ Reprer "SET" button, "04" of hour time blinks on screen

▶ Press "+" "-" button to adjust hour of time

▶ Reprer "SET" button again, "00" of minute time blinks on screen

▶ Press "+" "-" button to adjust minute of time

▶ Reprer "SET" button, temperature "40°C" blinks on screen

▶ Press "+" "-" button, to set the switch-on temperature of heating

▶ Then, Press "ESC" to exit this set and to access the switch-off time and temperature set

▶ Press "+" button, "tH 1F 05:00" displays on screen, the switch-off time and temperature for first time section of heating function can be set

▶ Press "SET" button, "05" of hour time blinks on screen.

▶ Press "+" "-" button to adjust hour of time

▶ Reprer "SET" button, "00" of minute time blinks on screen

▶ Press "+" "-" button to set minute of time

▶ Reprer "SET" button, temperature "45°C" blinks on screen

▶ Press "+" "-" button, to set switch-off temperature of heating

▶ Press "ESC" to exit this set program, parameters are saved automatically

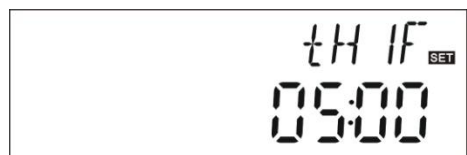

▶ Press “+” button, “tH 2o 10:00” displays on screen, the switch-on time and temperature for the second time section of heating function can be set

▶ Press “SET” button, “10” of hour time blinks on screen

▶ Press “+”“-” button to adjust hour of time

▶ Repress “SET” button, “00” of minute time blinks on screen

▶ Press “+”“-” button to adjust minute of time

▶ Repress “SET” button, temperature “50°C” blinks on screen

▶ Press “+”“-” button to adjust switch-on temperature of heating

▶ Then press “ESC” to exit this set and to access the switch-off time and temperature set

▶ Press “+” button, “tH 2F 10:00” displays on screen, set the switch-off time and temperature of second time section of heating function

▶ Press “SET” button, “10” of hour time blinks on screen

▶ Press “+”“-” button to adjust hour of time

▶ Repress “SET” button, “00” of minute time blinks on screen

▶ Press “+”“-” button to adjust minute of time

▶ Repress “SET” button, temperature “55°C” blinks on screen

▶ Press “+”“-” button, to adjust switch-off temperature of heating

▶ Press “ESC” to exit this set program, parameter is saved automatically

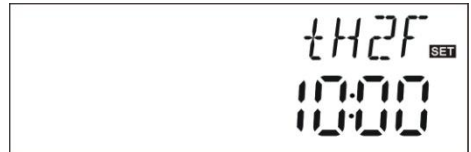
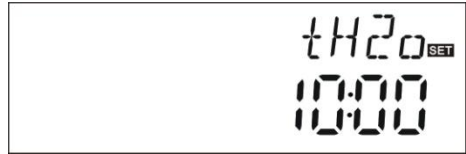

▶ Press “+” button, “tH 3o 17:00” displays on screen, set the switch-on time and temperature of the third time section of heating function

▶ Press “SET” button, “17” of hour time blinks on screen

▶ Press “+”“-” button, to adjust hour of time

▶ Repress “SET” button, “00” of minute time blinks on screen

▶ Press “+”“-” button, to adjust minute of time

▶ Repress “SET” button, temperature “50°C” blinks on screen

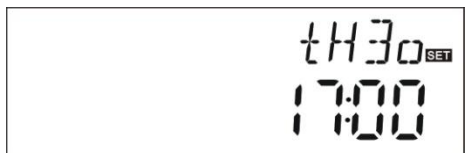

- ▶ Press “+”“-” button, to adjust switch-on temperature of heating
- ▶ Press “ESC” to exit this set program and to the switch-off time and temperature set
- ▶ Press “+” button, “tH 3F 22:00” displays on screen, the switch-off time and temperature of the third time section of heating function can be set
- ▶ Press “SET” button, “22” of hour time blinks on screen
- ▶ Press “+”“-” button, to adjust hour of time
- ▶ Re-press “SET” button, “00” of minute time blinks on screen
- ▶ Press “+”“-” button to adjust minute of time
- ▶ Re-press “SET” button, temperature “55°C” blinks on screen
- ▶ Press “+”“-” button to adjust switch-off temperature of heating
- ▶ Press “ESC” to exit menu, or wait for 20 seconds, set parameters are saved automatically



Note: when no gas or oil boiler is installed in system, electrical heater can be installed as back-up device, when electrical heater is in operation status, signal  blinks on screen.

If customer use electrical heater as back-up, please according to the power of electrical heater to equip corresponding safety devices like contactor and breaker with this controller, we strongly recommend equipping with SR802 device with this controller, (SR802 detailed technical data see spare parts)

5.function operation and parameter setup (engineer grade)

5.1 Access main menu

Under standby status, doing like following access main menu

▶ Press “SET” button, “PWD 0000” displays on screen, the left first digital blinks, ask for entering password, factory default set password is “ 0000”

▶ Press “+”“-” button to enter first digital of password.

▶ Press “SET” button again, the second digital blinks

▶ Press “+”“-” button button, to enter second digital of password

▶ Press “SET” button again, the third digital blinks

▶ Press “+”“-” button to enter the third digital of password

▶ Press “SET” button again, the fourth digital blinks

▶ Press “+”“-” button, to enter the fourth digital of password

▶ Press “SET” button again to access main menu

▶ Press “+”“-” button, can select the main menu

▶ Press “ESC” button to exit main menu



5.2 Access submenu

After selecting main menu, do like following access submenu

▶ Press “SET” button, to access submenu

▶ Press “+”“-” button to select submenu

▶ Press “SET” button again to access program, can adjust parameter value now

▶ Press “+”“-” button, to adjust the value of parameter

▶ Press “ESC” button, exit program of submenu

▶ Press “ESC” button again, to exit main menu.

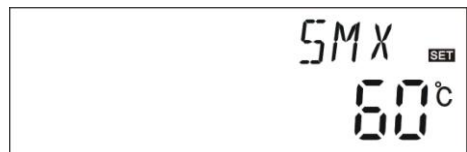

For example: submenu

5.3 Main menu DT O & DT F Temperature difference function

Description:

Solar circuit pump P1 is triggered by the temperature difference function, so long as the temperature difference between collector and tank reaches the switch-on DT, solar circuit pump is triggered.

For example: the switch-on DT is 8°C, switch-off DT is 4°C, if the temperature in the bottom part of tank is 20°C, then just when collector temperature rises up to 28°C, pump is triggered, and when collector temperature drops to 24°C, pump is ceased.

Note: the switch-on/off DT of 8°C and 4°C are standard system setting according to many years' experience, only in special application cases it needs to be changed, (e.g far distance heat transferring), normally it is recommend to use default set. Switch-on and switch-off DT are alternating set. To avoid mistake the minimum difference between two temperature differences ($\Delta T_{on} - \Delta T_{off}$) is set as 2°C.

- **Setup the switch-on temperature difference:**

Under standby status, access main menu DT O,

▶ Press “SET” button, to access settings program of DT O, “DT O 08°C” displays on screen, “08°C” blinks, the switch-on temperature difference can be set.

▶ Press “+”“-” button, to adjust the value of switch-on DT, adjustable range (OFF+2°C) ~20°C, factory setting is 8°C

▶ Press “ESC” button to exit this setting, parameter is saved automatically.



- **Setup the switch-off temperature difference:**

Under standby status, access main menu DT F

▶ Press “SET” button, to access settings program of DT F, “DT F 04°C” displays on screen, “04°C” blinks, the switch-off temperature difference can be set.

▶ Press “+”“-” button to adjust the value of switch-off DT, adjustable range 0°C ~ (ON-2°C), factory set is 4°C.

▶ Press “ESC” to exit menu, or wait for 20 seconds to exit automatically, the setup parameters are saved automatically.



5.4 TEMP Temperature main menu

For every system, the factory set parameters are in the best condition that is fully integrated into the entire solar system. But these parameters can also be set individually to cater the special requirements, please carefully observe the operation

data of system components after setting.

Note: parameters that can be set depend on the selected system, not all the parameters can be adjusted in a solar system.

Following submenu can be access though TEMP main menu.

Function	Adjustable range	Factory set	Function exit temperature
5.4.1 EMOF Collector maximum switch-off temperature	(ON+3°C) ~ 200°C	130°C	
5.4.1 EMON Collector maximum switch-on temperature	OFF-3°C) ~ 197°C	120°C	
5.4.2 CMX Maximum limited collector temperature (collector cooling function)	110°C ~ 190°C	110°C	107°C
5.4.3 CMN low temperature protection of collector	0°C ~ 90°C	OFF	
5.4.4 CFR frost protection of collector	-10°C ~ 10°C	OFF	
5.4.5 SMX Maximum temperature of tank	2°C ~ 95°C	60°C	58°C
5.4.6 REC Tank re-cooling function		OFF	
5.4.7 C-F Celsius and Fahrenheit temperature transferring	°C ~ °F	°C	

5.4.1 EM Emergency collector temperature(Emergency switch-off function)

Function description:

When temperature of collector rises up to the preset maximum switch-off temperature, collector emergency switch-off function is activated. As the result of this function, solar circulation pump is stopped,it avoids the damage of system components caused by over-heated temperature. EMOF parameter is for set maximum switch-off temperature of collector (factory set: 130°C), if the collector temperature rises up to preset EMOF temperature, solar pump is stopped;EMON parameter is for set maximum switch-on temperature of collector (factory set: 120°C),when the collector temperature drops to

EMON temperature, solar pump can be triggered again, collector emergency switch-off function is deactivated automatically.

● **EMOF collector maximum switch-off temperature**

Select submenu EMOF, “EMOF 130°C” displays on the screen.

▶ Press “ SET” button, parameter 130°C blinks on the screen.

▶ Press “ +, -“ button, to adjust the **EMOF**

temperature, adjustable range: (ON +3°C)~200°C, factory set is 130°C.

▶ Repress “SET” button, activate and

deactivate this function, if deactivate the function, “EMOF - - -” displays on screen.

▶ Press “ ESC” button to exit menu, or wait for 20 seconds to exit automatically, set parameter is saved automatically.



● **EMON collector maximum switch-on temperature**

Select submenu EMON, “EMON 120°C” displays on the screen.

▶ Press “ SET” button, parameter 120°C blinks on the screen.

▶ Press “ +,-“ button, to adjust the **EMON**

temperature, adjustable range:

(OFF-3°C)~200°C, factory set is 120°C.

▶ Repress “SET” button, activate and deactivate this function, if deactivate the function, “EMON- - -” displays on screen.

▶ Press “ ESC” button to exit menu, or wait for 20 seconds to exit automatically, set parameter is saved automatically.



☀️ ⓘ These two signals display on the screen, means collector emergency switch-off function is activated, and tank temperature rises up to its maximum permitted temperature.

ⓘ Only this signal displays on the screen, means this function is activated, but tank temperature doesn't rise up to its maximum temperature.

5.4.2 CMX Maximum limited collector temperature (collector cooling function)

Function description:

The collector cooling function delays the vaporization of the heat transfer fluid. Shortly before reaching the maximum temperature of the collector, the solar pump starts working in order to cool down the heat transfer fluid using the heat losses occurring in pipelines and storage cylinder.

When tank temperature rises to its preset maximal temperature, solar circuit pump is ceased compulsively even the temperature difference is satisfied. If the sunshine is very good, as a result collector temperature will rise continuously, when collector temperature rises up to its maximal temperature, solar pump will be triggered again even at the case that tank temperature is already to its maximal temperature. And solar pump works until the temperature of collector drops since this reversed circulation or when tank temperature rises its emergency temperature (95°C).

When ☀ displays, and ⚠ blinks on the screen, it indicates that tank emergency temperature reaches, tank temperature is $\geq 95^{\circ}\text{C}$

Setup steps:

To access main menu TEMP, then select submenu CMX “CMX 110°C” displays on screen

▶ Press “SET” button, parameter “110°C” blinks.

▶ Press “+”“-” button, to adjust the collector protection temperature, adjustable range (100°C~190°C) , factory set is 110°C

▶ Reprress “SET” button, activate and deactivate this function, if deactivate the function, “CMX - -” displays on screen.

▶ Press “ESC” button to exit the menu or wait for 20 seconds to exit automatically, parameters are saved automatically.



CMX signal displays on screen, it indicates that this function is in activated.

5.4.3 CMN low temperature protection of collector

Description:

When the temperature of collector is below preset CMN temperatures, solar circuit pump is ceased, even when the temperature difference between collector and tank exceeds switch-on temperature difference, solar pump doesn't work yet. When temperature of collector is 3°C higher that the preset CMN temperature, solar circuit pump is restarted, controller exits this program.

Setup steps:

To access main menu TEMP, then select submenu CMN, "CMN - - -" displays on screen, default set is off.

▶ Press "SET" button, default off signal "- - -" blinks on screen.

▶ Repress "SET" button, to activate and deactivate this function

▶ Press "+" "-" button, to adjust the low protection temperature of collector CMN, adjustable range

(00°C ~ 90°C), after activate the function, factory set is 10°C

▶ Press "ESC" button to exit the menu or wait for 20 seconds to exit automatically, parameters are saved automatically.



CMN signal displays on screen, it indicates that this function is in activated.

5.4.4 CFR frost protection of collector

Description:

In winter when the temperature of collector is below the preset frost protection temperature (factory set is 4°C), Solar circuit pump is triggered. Besides when tank temperature (T2) drops to 4°C, electrical heater is triggered automatically and it is in operation until T2 is heated up to 20°C or it is stopped when program of CFR is exited. When collector temperature rises up to 7°C, solar circuit pump is ceased, program of CFR exits automatically.

This function is used in system, which use water as heat transfer liquid, to avoid the

freezing of solar heat transfer fluid.

Setup steps:

To access main menu TEMP, then select submenu CFR, “CFR - - -” displays on screen, default set is off.

- ▶ Press “SET” button, default off “- - -” blinks.
- ▶ Re-press “SET” button, to activate or deactivate this function



- ▶ Press “+”“-” button, to adjust the frost protection function, adjustable range is ($-10^{\circ}\text{C} \sim 10^{\circ}\text{C}$), after function activated, default set is 4°C
- ▶ Press “ESC” button to exit the menu or wait for 20 seconds to exit automatically, parameters are saved automatically.

 CFR signal displays on screen, it indicates that this function is in activated.

Note: this function is only available in special solar system which using no-anti-freezing liquid; this kind of system is only suitable in area where the ambient temperature is near to 0°C in only few days. If safety requirement is very high, then anti-freezing is necessary, we suggest to use suitable anti-freezing liquid to avoid frost problem.

4.4.5 SMX Maximum temperature of tank

Description:

When the DT between collector T1 and Tank 2 caters the switch-on DT of circulation, solar pump is triggered, but in order to avoid the high temperature inside tank, controller will check whether the temperature (T3) of top part of tank is higher than maximum temperature of tank, when T3 is higher than preset SMX temperature, solar pump is ceased even at the case that DT caters condition. When tank temperature drops and is 2°C below the SMX, solar pump restarts when DT caters condition.

Setup steps:

To access main menu TEMP, then select submenu SMX, “SMX 60°C ” displays on screen.

- ▶ Press “SET” button, parameter “ 60°C ” blinks
- ▶ Press “+”“-” button to adjust the value of

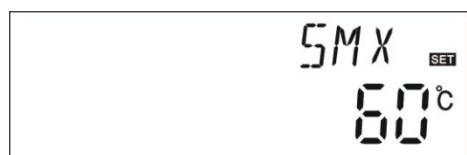

maximum temperature of tank1 adjustable range is (2°C~95°C) , default set is 60°C

▶ Repress “SET” button to activate and deactivate this function, if function deactivated, “SMX - - -” displays on the screen.

▶ Press “ESC” button to exit the menu or wait for 20 seconds to exit automatically, parameters are saved automatically.



SMX signal displays on screen, it indicates that this function is in activated.

5.4.6 REC Tank re-cooling function

Description:

If tank temperature is over tank’s maximum temperature, and at the same time, collector temperature is 5°C lower than tank temperature, then solar pump is triggered, through this reversed circulation, tank temperature is reduced by heat loss occurs in collector, solar pump keep in working until tank temperature drops below its maximum temperature.

Setup steps:

To access main menu TEMP, then select submenu REC, “REC OFF” displays on screen, default set is off.

▶ Press “SET” button, parameter “OFF” blinks on screen

▶ Repress “SET” button to activate or deactivate this function, after function activated; factory set is “REC ON”

▶ Press “ESC” button to exit the menu or wait for 20 seconds to exit automatically, parameters are saved automatically.



REC signal displays on screen, it indicates that this function is in activated.

5.4.7 C- F Celsius and Fahrenheit temperature transferring

Setup steps:

To access main menu TEMP, then select submenu C-F, “C-F °C” displays on screen.

- ▶ Press “SET” button, parameter “°C” blinks on the screen.
- ▶ Press “+” button, to select between Celsius and Fahrenheit temperature, factory set is °C
- ▶ Press “ESC” button to exit menu or wait for 20 seconds to exit automatically, parameters are saved automatically.

5.5 FUN Auxiliary function

The auxiliary function of this controller can be set under “FUN” submenu; it is possible to activate several auxiliary functions at the same time.

Note:

Sometimes, your selected function needs an extra signal input to connect temperature sensor or an extra output to connect pump or electromagnetic valve. in “FUN “submenu, some functions are deactivated. Hence, for different system, activated or deactivated status for following auxiliary functions in submenu is also different.

Example to explain:

If you set thermal energy measuring parameter (OHQM) is off, that means this function is deactivated, then, FMAX, MEDT and MED% functions are disappeared in the submenu, only when this function (OHQM) is activated, they are just appear in the submenu. (See detailed in §3.2 menu structure)

Following submenu can be accessed through menu “FUN”

DVWG Anti-Legionella function-----	5.5.1
CIRC Temperature controlled hot water circulation pump -----	5.5.2
nMIN Solar circuit pump speed adjusting (RPM speed controlling) -----	5.5.3
DTS Standard temperature difference (for circuit pump speed adjusting) -----	5.5.3.1
RIS Increase rate (for circuit pump speed adjusting)-----	5.5.3.2
OHQM Thermal energy measuring-----	5.5.4
FMAX Flow rate-----	5.5.4.1
MEDT Type of heat transfer liquid-----	5.5.4.2
MED% Concentration of anti-freezing liquid-----	5.5.4.3
INTV Pump interval function -----	5.5.5
tRUN Pump interval time-----	5.5.5.1

tSTP Pump running time-----5.5.5.2

BYPA High temperature by-pass function (tank temperature automatically adjusting)

-----5.5.6

5.5.1 DVWG Anti-Legionella function

Description:

In order to avoid occurring bacteria in water tank when the temperature of tank is lower for a long time, controller will check the temperature of tank every 7 days in a period automatically, if the temperature of tank is never over 70°C during this period, then at the factory set default time of 01:00 on the seventh day of the period auxiliary heating system is triggered automatically to heat water until it rises up to 70°C, bacteria is killed by high temperature, whereafter function is deactivated.

Setup steps:

To access main menu FUN, then select submenu DVWG, “DVWG OFF” displays on screen. Default set is “OFF”.

▶ Press “SET” button, parameter” OFF” blinks on the screen.

▶ Repress “+”“-” button, “DVWG ON” blinks on the screen, function is triggered.

▶ Press “ESC” button to exit the menu or wait for 20 seconds to exit automatically, parameters are saved automatically.



5.5.2 CIRC Temperature controlled hot water circulation pump

Description:

Solar system can provide temperature-controlled hot water circulation function; this function needs an extra hot water circulation pump (connect output port P2) and a sensor, which is installed on the return pipe of hot water (connect input port T4). When the temperature signal of sensor T4 is less than the preset turning on temperature of circulation pump, the hot water circulation pump (P2) triggers and works till the temperature exceeds the turning off temperature.

Factory set: the desired hot water temperature is 40°C, when return temperature T4 drops to 35°C, circulation pump P2 is triggered, when T4 rises up to 40°C, circulation pump P2 is ceased.

Condition for triggering hot water circulation pump: only when tank temperature T3 is 1°C higher than the required hot water temperature, hot water circulation pump just can be triggered. T3 is alternative sensor, when no sensor (T3) is installed in the top part of tank, controller will use the signal of sensor T2 automatically to control the circulation pump P2.

Note: in order to avoid large measuring error, the sensor T4 on hot water return pipe should be installed 1.5m far away from tank. This function isn't available in all systems.

Setup steps:

To access main menu FUN, then select submenu CIRC, "CIRC - - -" displays on screen, factory set is off.



- ▶ Press "SET" button, parameter "- - -" blinks on screen.
- ▶ Repress "SET" button, parameter "40°C" blinks on screen
- ▶ Press "+" "-" button, to adjust the temperature of hot water return, adjustable range: 2°C ~ 95°C , after function is activated, factory set is 40°C
- ▶ Press "SET" button again, "- - -" blinks on screen, function is deactivated

- ▶ Press "ESC" button to exit the menu or wait for 20 seconds to exit automatically, parameters are saved automatically.

5.5.3 nMIN Solar circuit pump speed adjusting (RPM speed controlling)

Note: SR868C8 doesn't have this function

Description:

P1 output can be configured to function either as RPM controlled output or simple switch output. When this function is activated, the output is RPM controlled output; when parameter is set as "nMIN"100%" the output becomes a normal switch output.

Normal switch output: circuit pump speed controlling is deactivated, pump is operated with a fixed speed, and flow rate is not changed.

RPM control output: (speed controlling is activated), the control system attempts to maintain a constant temperature difference between collector and tank. The pump performance is continuously adjusted and the volume flow pumped is increased or reduced, depending on the temperature difference.

Setup steps:

To access main menu FUN, then select submenu nMIN, “nMIN 30” displays on screen.

▶ Press “SET” button, parameter “30” blinks on the screen

▶ Press “+”“-” button, to adjust speed of circuit pump, adjustable range (30~100%), factory set is 30%

▶ Press “ESC” button to exit the menu or wait for 20 seconds to exit automatically, parameters are saved automatically.



5.5.3.1 DTS Standard temperature difference (for circuit pump’s speed adjusting)

Note: SR868C8 doesn’t have this function

Description:

When the switch-on temperature difference (ΔT ON) reaches, solar pump is triggered, and then within 20 seconds, pump speed reaches to its minimum speed (30%). Whereafter, controller checks continuously, when the standard temperature difference (DTS) reaches, the speed of pump increases one grade (10%), temperature difference RIS increases every 1°C, speed of pump increases 10% until it reaches to its maximum speed 100%. Through setting the temperature difference increase rate (RIS) can achieve the controlling of pump speed. If temperature difference drops to the switch-off TD(ΔT OFF), circuit pump is ceased.

Setup steps:

To access main menu FUN, then select submenu DTS, “DTS 08°C” displays on the screen

▶ Press “SET” button, parameter “08°C” blinks

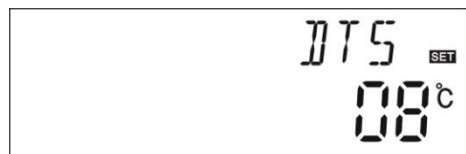

on the screen

- ▶ Press “+”“-” button, to adjust standard TD, adjustable range ($2^{\circ}\text{C}\sim 30^{\circ}\text{C}$), factory set is 08°C
- ▶ Press “ESC” button to exit the menu or wait for 20 seconds to exit automatically, parameters are saved automatically.

5.5.3.2 RIS Temperature increase rate (for circuit pump speed adjusting)

Note: SR868C8 doesn't have this function

Setup steps:

To access main menu FUN, then select submenu RIS, “RIS 01°C ” displays on screen.

- ▶ Press “SET” button, parameter “ 01°C ” blinks on the screen
- ▶ Press “+”“-” button, to adjust increase rate of (RIS) of temperature difference, adjustable range ($1^{\circ}\text{C}\sim 20^{\circ}\text{C}$), factory set is 1°C
- ▶ Press “ESC” button to exit the menu or wait for 20 seconds to exit automatically, parameters are saved automatically.



5.5.4 OHQM Thermal energy measuring

Note: SR868C8 doesn't have this function

Description:

Controller has function for measuring the thermal energy; it can measure the energy which from collector transfers to tank. For the sake of measuring, the temperature (T0, T1) on going and return pipe should be checked, and an extra flow meter should be installed on the circulation pipe, it is used for measuring the flow rate.

The thermal energy through solar system is calculated with measured parameter temperature T1, T0 and flow rate. Thermal energy get in the current day displays in DKWh, accumulative thermal energy displays in kWh or MWh.

Setup steps:

To access main menu FUN, then select submenu OHQM, “OHQM OFF” displays on screen,

Factory set is OFF

▶ Press “SET” button, parameter “OHQM OFF” blinks on the screen



▶ Repress “+”“-” button, to activate this

function, “OHQM oN” blinks on the screen

▶ Press “ESC” button to exit the menu or wait for 20 seconds to exit automatically, parameters are saved automatically.

Note:

1) Thermal energy achieved in current day, accumulative thermal energy and operation time of pump can be reset, doing like following

Operation steps: under standby status, doing like following

▶ Press “+”“-” button, select to check the thermal energy of current day, “DKWH XX” “SET” displays on the screen.

▶ Press “SET” button for 3 seconds, buzzer makes 3 times “du - - - ”, the daily thermal energy is cleared, and daily thermal energy is reset to “00”.

▶ Press “+”“-” button, select to check accumulative thermal energy, “KWH XX” or “MWH XX” “SET” displays on the screen.

▶ Press “SET” button for 3 seconds, buzzer makes 3 times “du - - -”, the sum thermal energy is cleared, accumulative thermal energy is reset to “00”.

▶ Press “+”“-” button, select to check operation time of pump, “hP XX” “SET” displays on the screen.

▶ Press “SET” button for 3 seconds, buzzer makes 3 times “du - - -”, the operation time of pump is cleared, and it is reset to “00”.

2) Only when the thermal energy balance function is activated, operation time of circulation pump function just can be triggered.

5.5.4.1 FMAX Flow rate

Note: SR868C8 doesn't have this function

FAMX: Flow rate L/min. adjustable range: (0.1~20) L/min, increase rate 0.1L per time, factory set is 2.0L/min

Setup steps:

To access main menu FUN, then select submenu FMAX, "FMAX 2.0" displays on screen.



▶ Press "SET" button, parameter "2.0" blinks on the screen

▶ Press "+" "-" button to adjust parameter of flow rate. adjustable range (0.1~20)

▶ Press "ESC" button to exit the menu or wait for 20 seconds to exit automatically, parameters are saved automatically.

5.5.4.2 MEDT Type of heat transfer liquid

Note: SR868C8 doesn't have this function

MEDT: type of heat transfer liquid, adjustable range (00~03), factory set : 01

Type of heat transfer liquid:

00: Water

01: Propylene glycol

02: Glycol

03: Tyfocor LS/G-LS

Setup steps:

To access main menu FUN, then select submenu MEDT, "MEDT 01" displays on screen.

▶ Press "SET" button, parameter "01" blinks on the screen



▶ Press "+" "-" button, to adjust type of heat transfer liquid, adjustable range (00~03)

▶ Press "ESC" button to exit the menu or wait for 20 seconds to exit automatically, parameters are saved automatically.

5.5.4.3 MED% Concentration of heat transfer liquid

Note: SR868C8 doesn't have this function

MED% Concentration of heat transfer liquid (volume percentage %), depending on the

type of heat transfer liquid, adjustable range (20 ~70), factory set 40%

Setup steps:

To access main menu FUN, then select submenu MED%, “MED% 40” displays on screen.

▶ Press “SET” button, parameter “40” blinks on the screen

▶ Press “+”“-”button to adjust concentration, adjustable range (20~70)

▶ Press “ESC” button to exit the menu or wait for 20 seconds to exit automatically, parameters are saved automatically.



5.5.5 INTV Pump interval function

Note: SR868C8 doesn't have this function

Description:

This function is useful when collector sensor isn't installed in collector (sensor installed on the outlet pipe of collector). In order to measure the actual temperature of collector, within the preset interval, solar pump is triggered like pulse, so that the hot water inside collector can flow to the pipe, where sensor is mounted, as the result, the actual temperature of collector is measured. It is unnecessary to activate this function in all time, you can use it within a preset time section, default set time is 06:00 ~20:00.

During the period that solar pump is in operating, (the period of running time can be set by parameter “tRUN”), controlled check the temperature signal of sensor, if the temperature increases less than 1°C, then solar pump is ceased automatically. After the break time (interval can be set by parameter “tSTP”), same process repeats.

During the period that solar pump is in operating, if measured temperature increases over 1°C, then the next interval is omitted, this omitting repeats when it caters condition and until the switch-on temperature difference is catered or no more temperature can be measured. After that, pump interval function recovers to pulse rate-controlled mode.

Setup steps:

To access main menu FUN, then select submenu INTV, "INTV OFF" displays on screen.

▶ Press "SET" button, parameter "OFF" displays and blinks, factory set is "OFF"

▶ Press "+" "-" button, to activate this function, "INTV ON" displays on the screen.

▶ Press "ESC" button to exit the menu or wait for 20 seconds to exit automatically, parameters are saved automatically.

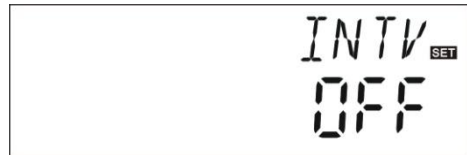

5.5.5.1 tSTP Pump interval- time

Note: SR868C8 doesn't have this function

Setup steps:

To access main menu FUN, then select submenu tSTP, "tSTP 30" displays on screen.

▶ Press "SET" button, parameter "30" blinks on screen, factory set is "30" minutes.

▶ Press "+" "-" button to adjust the loading time, adjustable range: 10~60 minutes,

▶ Press "ESC" button to exit the menu or wait for 20 seconds to exit automatically, parameters are saved automatically.



5.5.5.2 tRUN Pump running time

Note: SR868C8 doesn't have this function

Setup steps:

To access main menu FUN, then select submenu tRUN, "tRUN 10" displays on screen.

▶ Press "SET" button, parameter "10" blinks on screen, factory set is 15 second. .

▶ Press "+" "-" button to adjust the running time, adjustable range: 5~120 seconds

▶ Press "ESC" button to exit the menu or wait for 20 seconds to exit automatically, parameters are saved automatically.

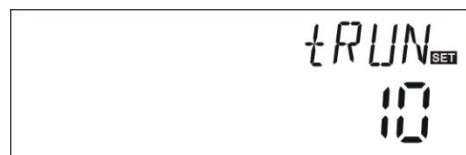

5.5.6 BYPA High temperature by-pass function (tank temperature automatically adjusting)

Description:

High-temperature bypass role is independent of the solar system's operation; the extra thermal energy of tank can be transferred to other application through this function, as a result the constant tank temperature can be kept. In order to transfer this extra energy, it needs an extra pump or electromagnetic valve. (Connect to output port R1).

For example:

If we set the temperature of bypass is 70°C, then when tank temperature (T3) rises up to 71°C, this by-pass function is triggered, electromagnetic valve or circuit pump (R1) and TD controlled circuit pump (P1) will be triggered simultaneously. When tank temperature (T3) drops to 67°C, electromagnetic valve or circuit pump (R1) and TD controlled circuit pump (P1) will be ceased simultaneously.

Setup steps:

To access main menu FUN, then select submenu BYPR, "BYPR - - -" displays on screen.



▶ Press "SET" button, "- - -"blinks on screen, default set is "OFF"

▶ Repress "SET" button, to activate by-pass function, "BYPR 80°C" displays on the screen, "80°C" blinks

▶ Press "+" "-" button to adjust this parameter, adjustable range (5°C ~ 120°C)

▶ Press "ESC" button to exit the menu or wait for 20 seconds to exit automatically, parameters are saved automatically.

 This signal displays on the screen, it indicates by-pass function is activated.

● Application example

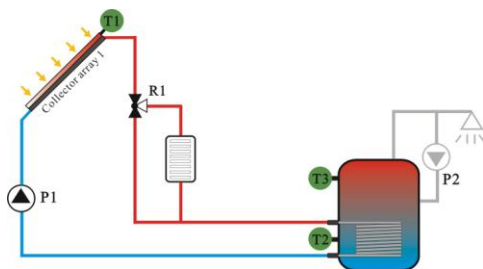

Picture1

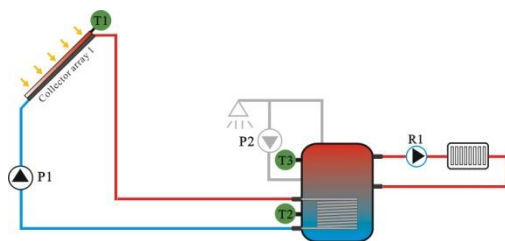

Picture2

5.6 HND Manual mode

When using this controller first time or when debugging this controller, output of this controller (P1, P2, R1, H1) can be triggered manually. “On, OFF” control.

Setup steps:

To access main menu HND,

▶ Press “SET” button, “HND1 off” displays on the screen, P1 output manually set

▶ Repress “SET” button, “HND1 on” displays on the screen, P1 output is switched-on

▶ Repress “SET” again, “HND1 off” displays, P1 output is switched-off

▶ Press “ESC” to exit P1 set program



▶ Press “+” button, “HND2 off” displays on the screen, P2 output manually set

▶ Press “SET” button, “HND2on” displays on the screen, P2 output is switched-on

▶ Repress “SET” again, “HND2off” displays, P2 output is switched-off

▶ Press “ESC” to exit P2 set program

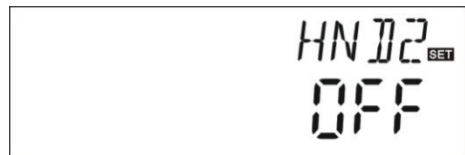

▶ Press “+” button, “HND3 off” displays on the screen, R1 output manually set

▶ Press “SET” button, “HND3 on” displays on the screen, R1 output is switched-on

▶ Repress “SET” again, “HND3 off” displays, R1 output is switched-off

▶ Press “ESC” to exit R1 set program



▶ Press “+” button, “HND4 off” displays on the screen, H1 output manually set

▶ Press “SET” button, “HND4 on” displays on the screen, H1 output is switched-on

▶ Repress “SET” again, “HND4 off” displays, H1 output is switched-off



▶ Press “ESC” to exit H1 set program

Note: when manual mode is  activated, signal displays on the screen, after 15 minutes all outputs are switched-off, controller exits manual mode automatically.

5.7 PASS Password setting

Setup steps:

To access main menu PASS,

▶ Press “SET” button, “PWDC 0000”, the left digital blinks, ask for to enter the password, factory set is “0000”

▶ Press “+”“-” button to enter the first digital

▶ Repress “SET” button, the second digital blinks

▶ Press “+”“-” button to enter the second digital

▶ Repress “SET” button, the third digital blinks

▶ Press “+”“-” button to enter the third digital

▶ Repress “SET” button, the fourth digital blinks

▶ Press “+”“-” button to enter the fourth digital

▶ Press “SET” button, “PWDN 0000” displays on the screen, ask for entering a new password, doing like above to enter the new password

▶ Press “SET” button, “PWDG 0000” displays

on the screen, ask for reentering the new password, doing like above to reenter the new password, “PWOK” displays on the screen to indicate reentering password successfully.

▶ Press “ESC” button to exit set program or wait for 20 seconds to exit automatically.



Warning!

If the password is forgot, it is not possible to recover, but you can recover the password to factory set, then you can reedit a password like above descript steps, doing like following to recover to factory set.



► Open cover in the front of the display, Press  and hold on, then repress the recovery button, which on the display plate.

► Buzzer makes “du - - -” 3 times, then release  button. Controller recovers to factory set, a new password can be reset now.

5.8 LOAD Recovery factory setting

Setup steps:

To access main menu REST,

► Press “SET” button, “YES” displays on the screen.



► Hold down “SET” button, buzzer makes “du - - -” 3 times, then release “SET” button. Controller recovers to factory set, new parameters can be reset now.

► Press “ESC” button to exit set program or wait for 20 seconds to exit automatically.

5.9 ON/OFF button

Under the standby status,

► Press  button for 3 seconds; controller is switched off, “OFF” displays on the screen.

► Repress  button, controller is switched-on again.

5.10 Holiday function

Description:

This function activates at night, solar liquid will flow from storage tank to collector to cool the tank, and therefore to prevent high thermal loads problem of the solar system due to completely heated storage tank. The function is activated at night between 10 pm and 6 am, when the collector temperature drops 8 °C below the storage tank temperature (T2), solar circuit pump starts to work; when the temperature of collector is 2°C below the tank temperature, and solar circuit pump is ceased.

Activate this function if:

- You intend to be absent for an extended period (holiday)
- No hot water is required for an extended period.

Note: The function is deactivated when the temperature in lower section of storage tank falls down to 35°C.

Activate/ deactivate this function:

- ▶ Press “Holiday” button for a long time until the signal of holiday function displays on the screen, and then holiday function is activated.
- ▶ Repress “Holiday” button, signal disappears, holiday function is deactivated.

Note:

This function is only activated when you are not at home for long time, when you come back; please make sure to deactivate it.

5.11 Manual heating



Description:

Electrical heater, gas or oil boiler can be as back-up devices in a solar system, this controller can achieve constant temperature controlling, when controller gets temperature signal of top part tank (T3) is 2°C below the preset temperature, back-up heating will be triggered. When temperature of top part tank (T3) reaches to the preset temperature, heating is ceased.

Conditions for triggering manual heating function: the setting temperature should be 2°C higher than tank temperature.

Activate/deactivate the function:

- ▶ Press “Heating” button, temperature “60°C” blinks on the screen.
- ▶ Press “+”“-” button to adjust switch-on temperature, adjustable range 10°C ~80°C, factory set is 60°C.

After 20 seconds, this function is activated, signal  displays on the screen, and heating signal  blinks also.

- ▶ Press “Heating” button again, to switch-off manual heating function.

Note: manual heating can only heat tank one time, after manual heating is triggered, when temperature of tank rises up to the preset temperature, manual heating ceases, and manual heating function will be deactivated automatically, if customer wants to heat again, you need redo according to above steps.

5.12 Temperature query function

Under standby status,

▶ Press “+”“-” button can check the value of temperature sensors T0~ T4, pump speed (n %), accumulative operation time of circuit pump (Hp), daily thermal energy (DKWH), accumulative thermal energy (KWH) or (MWH).

When checking temperature, T0 – T4 will displays one by one, corresponding sensor signal  blinks.

▶ Press “ESC” button, clock and tank temperature can be displayed.

Note:

- Value of accumulative operation time of circuit pump (Hp), daily thermal energy (DKWH) and accumulative thermal energy (KWH) or (MWH) can only be checked after triggering of OHQM thermal energy balance function.
- Press “+”“-” button can check the value of temperature sensors T1~ T4.

6. Protection function

6.1. Memory protection

In case power failure occurs, controller keeps the parameter settings unchanged.

6.2 Screen protection

When no any press on button for 3 minutes, screen protection is activated automatically, and then LCD lighting lamp is switched-off. Through press any button to light LCD lamp again.





7. Trouble shooting

7.1 Trouble protection

a. When there is a break or short circuit between the connection of temperature sensors, controller switches off the corresponding functions and no more output signals are given, at the same time error signals  are showed on the display.

If control unit does not work correctly, please check following points.



► Press “+”“-” button to check error code,  signal displays on the LCD screen

Error message on LCD screen	Meaning	Cause of error	Error rectification
 T0 ---	T0 sensor problem	Sensor wiring interrupted, not connected or short circuit	Check resistance value, replace
	Thermal measuring function is switched-on	T0 sensor not connected	Connect T0 or switch-off this function (OHQM)
 T1 ---	T1 sensor problem	Sensor wiring interrupted, not connected or short circuit	Check resistance value, replace
 T2 ---	T2 sensor problem	Sensor wiring interrupted, not connected or short circuit	Check resistance value, replace
 T4 ---	T4 sensor problem	Sensor wiring interrupted, not connected or short circuit	Check resistance value, replace
	hot water circulation pump function turn-on	T4 not installing	Install T4 or switch-off this function

7.2 Trouble checking

The controller is quality product, conceived for years of continuous trouble-free operation. If a problem occurs, the cause of the problem very often lies not in the controller but in the peripheral components. The following description of some well-known problems should help the installer and operator to isolate the problem, so that the system can be place back into operation as quickly as possible and to avoid

unnecessary costs. Of course, not all possible problems can be listed here. However, most of the normal problems encountered with the controller can be found in the list below, only return the controller to seller when you are absolutely sure that none of the problems listed below is responsible for the fault.

Symptoms	Secondary symptoms	Possible cause	Procedure
Controller does not appear to function at all	Display shows nothing, no display illumination	Controller power supply is interrupted or program is out of work	Check the controller power cable Press reset button
The solar pump doesn't operate, despite the fact that switch-on conditions are satisfied	The pump symbol in the display blinks	Pump power supply is interrupted	Check the pump power cable
Pump doesn't operate	The pump symbol in the display doesn't blink.  Lighted or  blinks	The maximum storage tank temperature (SMX) has been reached The maximum collector temperature (EM) has been reached.	No fault

	 T1- - - Error message displays on the screen	Fault (short circuit or open circuit) in a temperature sensor	On the controller, request the current values from all connected temperature sensors, replace all defective sensors and /or cabling.
The solar pumps operated, despite the fact that the switch-on conditions are not satisfied.	The pump symbol in the display blinks.	Holiday function or Frost protection function or tank re-cooling function is activated.	No problem, it is normal. If necessary to deactivate the corresponding functions.
One function can't be activated	There is no function selection in submenu	All inputs and outputs are used; inputs and outputs can't be used doubly.	No fault on controller



Warning! Remove the device from the mains supply before opening the case
 A potentially defective sensor can be checked using an ohmmeter. To do this, the sensor must be disconnected, its resistance measured, and the value compared with the figures in the table below, small deviation ($\pm 1\%$) is acceptable,

PT1000 resistance value

°C	0	10	20	30	40	50	60	70	80	90	100	110	120
Ω	1000	1039	1077	1116	1155	1194	1232	1270	1309	1347	1385	1422	1460

NTC 10K B=3950 resistance value

°C	0	10	20	30	40	50	60	70	80	90	100	110	120
Ω	33620	20174	12535	8037	5301	3588	2486	1759	1270	933	697	529	407

8. Quality Guarantee

Manufacturer provides following quality responsibilities to end-users: within the period of quality responsibilities, manufacturer will exclude the failure caused by production and material selection. A correct installation will not lead to failure. When a user takes incorrect handling way, incorrect installation, improper or crud handling, wrong connection of sensor in system and incorrect operation, the quality responsibility is invalid for them.

The warrantee expires within 24 months after the date of purchasing the controller.

9. Technical data

Type Specification	SR868C8Q	SR868C8
Appearance of controller	120mm×120mm×18mm	120mm×120mm×18mm
Power supply	AC100~240V	AC100~240V
Power consumption	< 2W	< 2W
Accuracy of temperature measuring	$\pm 2^{\circ}\text{C}$	$\pm 2^{\circ}\text{C}$
Range of collector temperature measuring	-10~220°C	-10~220°C
Range of tank temperature measuring	0~110°C	0~110°C
Suitable power of pump	3PCS, $\leq 300\text{W}$	3PCS, $\leq 300\text{W}$
Suitable power of electrical heater	1PCS, $\leq 1500\text{W}$	1PCS, $\leq 1500\text{W}$
Inputs	2 x Pt1000 sensor ($\leq 500^{\circ}\text{C}$) for collector (silicon cable $\leq 280^{\circ}\text{C}$), 3 x NTC10K, B3950 sensor ($\leq 135^{\circ}\text{C}$) for tank, (PVC cable $\leq 105^{\circ}\text{C}$),	1 x Pt1000 sensor ($\leq 500^{\circ}\text{C}$) for collector (silicon cable $\leq 280^{\circ}\text{C}$), 2 x NTC10K, B3950 sensor ($\leq 135^{\circ}\text{C}$) for tank, (PVC cable $\leq 105^{\circ}\text{C}$),

Outputs	3 relays, for circulation pumps or 3-way electromagnetic valve 1 relay for electrical heater	3 relays, for circulation pumps or 3-way electromagnetic valve 1 relay for electrical heater
Ambient temperature	-10~50 °C	-10~50 °C
Water proof grade	IP40	IP40

- Note: If main supply AC110V, output power of relay as below:
 Suitable power of pump: 3PCS, ≤150W
 Suitable power of electrical heater: 1PCS, ≤750W

10. Delivery scope

Lists	Type	SR868C8Q	SR868C8
Display		1	1
Controller		1	1
Operation manual		1	1
PT1000 sensor (size: Φ 6*50mm, cable length 1.5m)		2	1
NTC10K (size: Φ 6*50mm, cable length 3m)		3	2
Plastic expansion screw		4	4
Screw		4	4
Strain-relief clamp		1	1

11. Accessories

- Sensor for collector: high accuracy PT1000 sensor(A01)
Parameter: PT1000, Φ 6X50mm

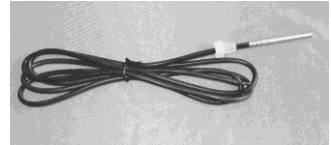

- Sensor for tank: high accuracy NTC 10K sensor (A02)
Parameter: NTC10K,B=3950, Φ 6X50mm

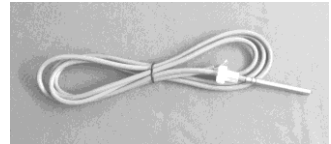

- Thermowell of sensor: stainless thermowell (A05)
Parameter: 1/2' male thread, Φ 8X200mm.

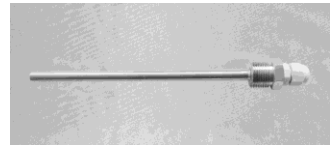

- Contactor unit of high power: SR802

When user selects electrical heater as back-up device, we recommend using SR802 unit connecting controller and electrical heater.

Technical data of SR802

Dimension: 100mmx100mmx65mm

Power supply:180V~264V/AC 50/60Hz

Suitable power: \leq 4000W

Available ambient temperature: -10 ~ 50°C

Water proof grade: IP43



● SR802 CONNECTION DIAGRAM:

