

# Controller for Solar Hot Water Project Installation and Operating Manual

## SR530F8 User Manual



***Please read this manual carefully before using!***

## Content

1. Safety information.....	3
1.1 Installation and commissioning .....	3
1.2 About this manual .....	3
1.3 Liability waiver .....	3
1.4 Description of symbols .....	4
2. Controller Installation .....	4
2.1 Installing controller .....	4
2.2 Wire arrangement.....	4
2.3 Installing the pressure water level transmitter .....	5
2.4 Installing electropolar water level transmitter .....	6
2.5 Terminal connections .....	6
2.6 Advice regarding the installation of temperature sensors .....	7
3. Commissioning.....	8
3.1 Set time/week.....	8
3.2 Menu structure .....	9
3.3 Menu description .....	10
4 System description .....	11
5. Function description and parameters setup .....	12
5.1 Access the main menu .....	12
5.2 DT Temperature difference .....	13
5.3 HIGH High、Middle、Low water position level setup.....	14
5.4 TEMP Temperature main menu .....	14
5.4.1 CFR frost protection of collector .....	15
5.4.2 SMX1 Maximum temperature of storage .....	16
5.4.3 CMN low temperature protection of collector .....	17
5.4.4 WT1 Water Loading Temperature .....	17
5.4.5 MAX1 Maximum switch off temperature of floor heating (for heat transferring between storage and heating return).....	18
5.4.6 MIN1 Minimum switch on temperature of storage (for heat transferring between storage and heating return) .....	19
5.4.7 AH1O Switch-on temperature for self-heating tape .....	19
5.5 FUN Auxiliary function .....	20
5.5.1 CIRC Switch-on/off control of hot water circuit pump .....	20

5.5.2 WMOD Water loading mode .....	21
5.5.3 STYP selecting the type of the water level sensor.....	22
5.5.4 OVER anti overflow protection function (optional) .....	23
5.5.5 AUX Temperature difference control function for floor heating .....	24
5.5.6 AHEA Switch-on/off control of back-up heating system .....	25
5.6 tHEA Timing heating .....	26
5.7 tWAT Timing Water Loading .....	29
5.8 tCYC Time or Temperature controlled DHW pump .....	32
5.9 tIMO Timer function.....	37
5.10 HND Manual mode .....	38
5.11 PASS Password setting.....	40
5.12 RSET Recovery factory setting.....	41
5.13 On/OFF button.....	41
5.14 Manual heating .....	41
5.15 Manual Water Loading .....	42
5.16 Temperature check.....	43
6. Protection function.....	43
6.1. Memory protection .....	43
6.2 Screen protection .....	43
7. Trouble shooting .....	44
7.1 Trouble protection.....	44
7.2 PT1000/NTC10K resistance value .....	44
8. Quality Guarantee.....	45
9. Technical data.....	45
10. Delivery scope.....	45
Appendix1: (SR530F8 type B) .....	46

## **1. Safety information**

### **1.1 Installation and commissioning**

- When laying cables, please ensure that no damage occurs to any of the constructional fire safety measures presented in the building.
- The controller must not be installed in rooms where easily inflammable gas mixtures are present or may occur.
- The permissible environmental conditions can't be exceeded at the site of installation.
- Before connecting the device, make sure that the energy supply matches the specifications that controller requires.
- All devices connected to the controller must conform to the technical specifications of the controller.
- All operations on an open regulator are only to be conducted cleared from the power supply. All safety regulations for working on the power supply are valid.
- Connecting and /or all operations that require opening the regulator (e.g. changing the fuse) are only to be conducted by specialists.

### **1.2 About this manual**

This manual describes the installation, function and operation of a solar thermal controller. When installing the remaining components e.g. the solar collectors, pump assemblies and the storage unit, are sure to observe the appropriate installation instructions provided by each manufacturer. Only trained professional personnel may only perform installation, electrical connection, commissioning and maintenance of the device. The professional personnel must be familiar with this manual and follow the instructions contained herein.

### **1.3 Liability waiver**

The manufacturer cannot monitor the compliance with these instructions or the circumstances and methods used for installation, operation, utilization and maintenance of this controller. Improper installation can cause damages to material and person. This is the reason why we do not take over responsibility and liability for losses, damages or cost that might arise due to the improper installation, operation or wrong utilization and maintenance or that occurs in some connection with the aforementioned. Moreover we do not take over liability for patent infringements or infringements – occurring in connection with the use of this controller- on third parties rights. The manufacturer preserves the right to put changes to product, technical date or installation and operation instructions without prior notice. As soon as it becomes evident that safe operation is no longer possible (e.g. visible damage). Please immediate take the device out of operation. Note: ensure that the device cannot be

accidentally placed into operation.

## 1.4 Description of symbols



### Safety instruction:

The safety instructions in the manual are marked with a warning triangle. They indicate measures, which can lead to personal injury and safety risks.

**Operation steps:** small triangle “▶” is used to indicate operation step.

**Notes:** Contains important information about operation or function.

## 2. Controller Installation

Controller can only be installed indoors, far away from dangerous place and away from the electromagnetic field.

### 2.1 Installing controller

**Note:** the controller can only be mounted in an area having an adequate level of protection.

- ▶ Determine the mounting site of controller.
- ▶ Drill the upper fixing hole on the wall.
- ▶ Fasten a screw.
- ▶ Move the terminal cover.
- ▶ Hang the base plate on the position ① (showed in picture).
- ▶ Mark the position of 2 bottom holes ② ③.
- ▶ Remove the base plate.
- ▶ Drill the bottom fixing hole.
- ▶ Rehang the base plate on the screw ①.
- ▶ Fastened screw on ② ③ and fix base plate..

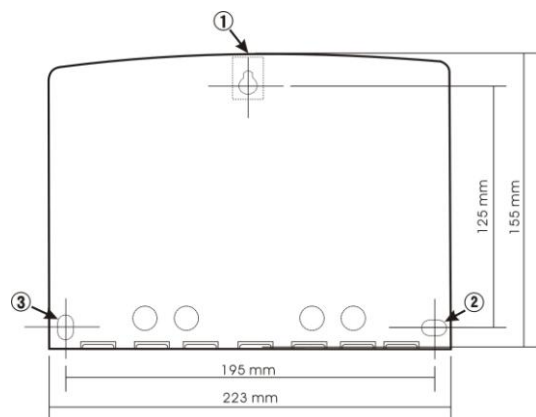

### 2.2 Wire arrangement

Depending on the type of installation, the cables may enter the controller through the rear hole of the case ④ or the lower side hole of the case.

**Cable comes from the rear hole ④:** Remove the plastic flaps ⑤ from the rear side of the case using an appropriate tool.

**Cable comes from the below hole:** Cut the left and right plastic flaps using an appropriate tool (e.g. knife) and break them out of the case.

**Notes:** the flexible wire must be fixed on the case using the clamps ⑥ provided with controller.

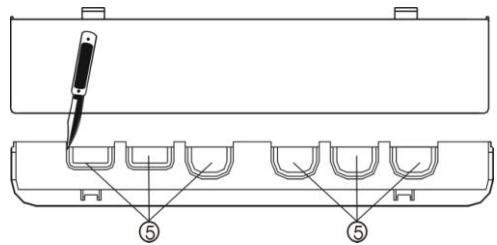
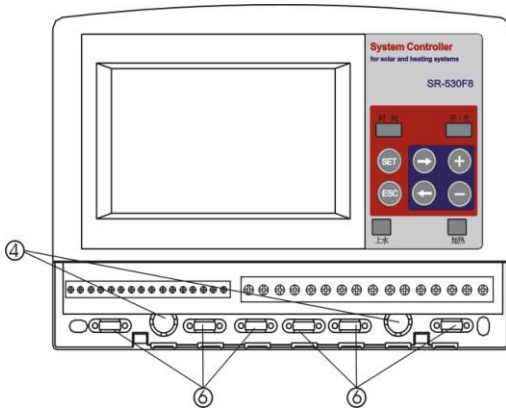

### 2.3 Installing the pressure water level transmitter

► Wrap some sealed tape on the sensor connector of water storage, insert sensor into the connector of the water storage, fasten the copper connector and screw the sensor clockwise, fasten it on the connector, see left picture.

► Connect the sensor cable with controller, and note the polarity of wire (red wire for positive polarity, blue wire for negative polarity).

► Mount the sensor at place where is vented, dry, no corrosion and shady possible, water immersing and moisture in the terminal of transmitter cable is forbidden.

► Switch-on power to controller, open the drainage valve D2, and wait until water flows out from D2 continuously, then close the valve D2.

**Note:**

- Mounting a valve D1 /D2 between pressure transmitter and water storage for easy maintenance.

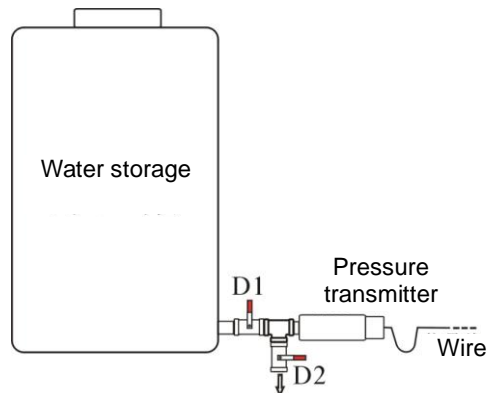

Mounting the pressure water level transmitter



Sample of pressure transmitter

- Using Honeywell water level transmitter in the controlling system. (Red wire connected on “+”polarity, blue wire connected on “-”polarity).

## 2.4 Installing electropolar water level transmitter

### Connection the electropolar water level transmitter:

Red wire of the three wires – connect L2 port 1

White wire of the three wires – connect L2 port 2

Black wire of the three wires – connect L2 port 3

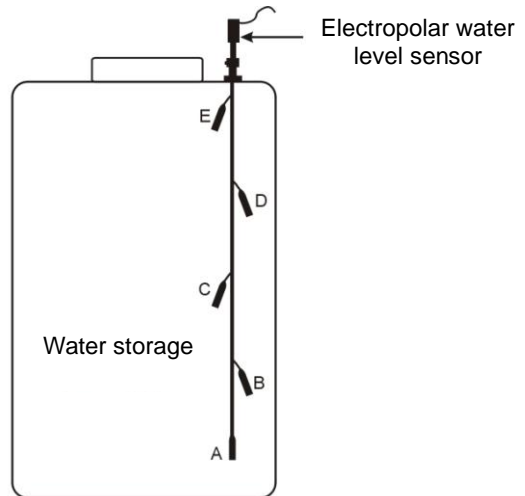

A、 B、 C、 D、 E Electro polar

## 2.5 Terminal connections



Before to open the terminal, please be sure to switch-off the power and pay attention to the local electricity supply rules.

### ● Input ports

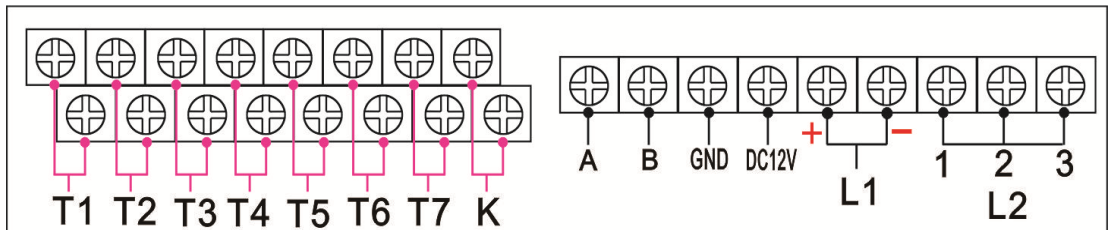

- 1) Input T1 for PT1000 temperature sensor, temperature resistance  $\leq 500^{\circ}\text{C}$
- 2) Input T2、 T3、 T4、 T5、 T6、 T7 for NTC10K, B=3950 temperature sensor, temperature resistance  $\leq 135^{\circ}\text{C}$

3) Input k:for floating device(anti overflow protection)

#### 4) L1 for pressure water level transmitter:

Water level height is less than ( $\leq$ ) 2.5 meter, red wire connect to “+” polarity, black wire connect to “-” polarity,

**Note** not reversed the wire polarity.

5) L2 for electropolar water level transmitter:

Port 1: Connect the red wire

Port 2: Connect the white wire

Port 3: connect the black wire

6) Communication Port : Remote control wires connects with A、B、GND correspondingly.

- **Output ports**

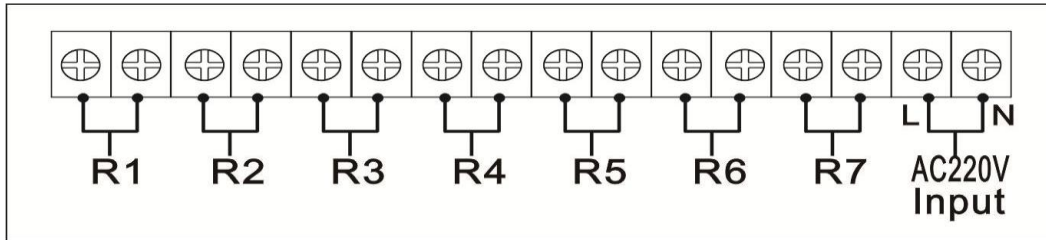

1) For power connection:"L" is live wire,"N" is naught wire.

2) Output ports R1、R2、R3、R4、R5、R6、R7 are electromagnetic relays, maximum switch-on current: 5A.

### 2.6 Advice regarding the installation of temperature sensors

- Only original factory enclosed Pt1000 temperature sensors are approved for use with the collector, it is equipped with 1.5meter silicon cable and suitable for all weather conditions, the temperature sensor and cable are temperature resistant up to 280 °C, not necessary to distinguish the positive and negative polarity of the sensor connection.
- Only original factory enclosed NTC10K,B=3950 temperature sensors are approved for use with tank and pipe, it is equipped with 1.5meter PVC cable, and they are temperature resistant up to 105 °C, not necessary to distinguish the positive and negative polarity of the sensor connection.
- Sensor cables may be extended to a maximum length of ca. 100 meter, when cable's length is up to 50m, and then 0.75mm<sup>2</sup> cable should be used. When cable's length is up to 100m, and then 1.5mm<sup>2</sup> cable should be used.
- All sensor cables carry low voltage, and to avoid inductive effects, must not be laid close to 230 volt or 400-volt cables (minimum separation of 10cm)



- If external inductive effects are existed, e.g. from heavy current cables, overhead train cables, transformer substations, radio and television devices, amateur radio stations, microwave devices etc, then the cables to the sensors must be adequately shielded.

### 3. Commissioning



Connect the sensors, pumps or switching valves to the controller before you switch-on the power supply! After switching on power to the controller, firstly it will ask for to set the time of controller.

#### 3.1 Set time/week

▶ Press “Clock” button, time displays on the screen, hour selection area “00” blinks on the display screen.

▶ Press “+/-” button to set hour of clock

▶ Press “Clock” button again, Minute area “00” blinks

▶ Press “+/-” button, to set minute of clock.

▶ Press “Clock” again, week area “WE” blinks

▶ Press “+/-” button, to set week.



After setting and wait for 6 seconds to save the parameter automatically. Current time and week are displayed on the controller.

Code	Weekday
MO	Monday
TU	Tuesday
WE	Wednesday
TH	Thursday
FR	Friday
SA	Saturday
SU	Sunday

### 3.2 Menu structure

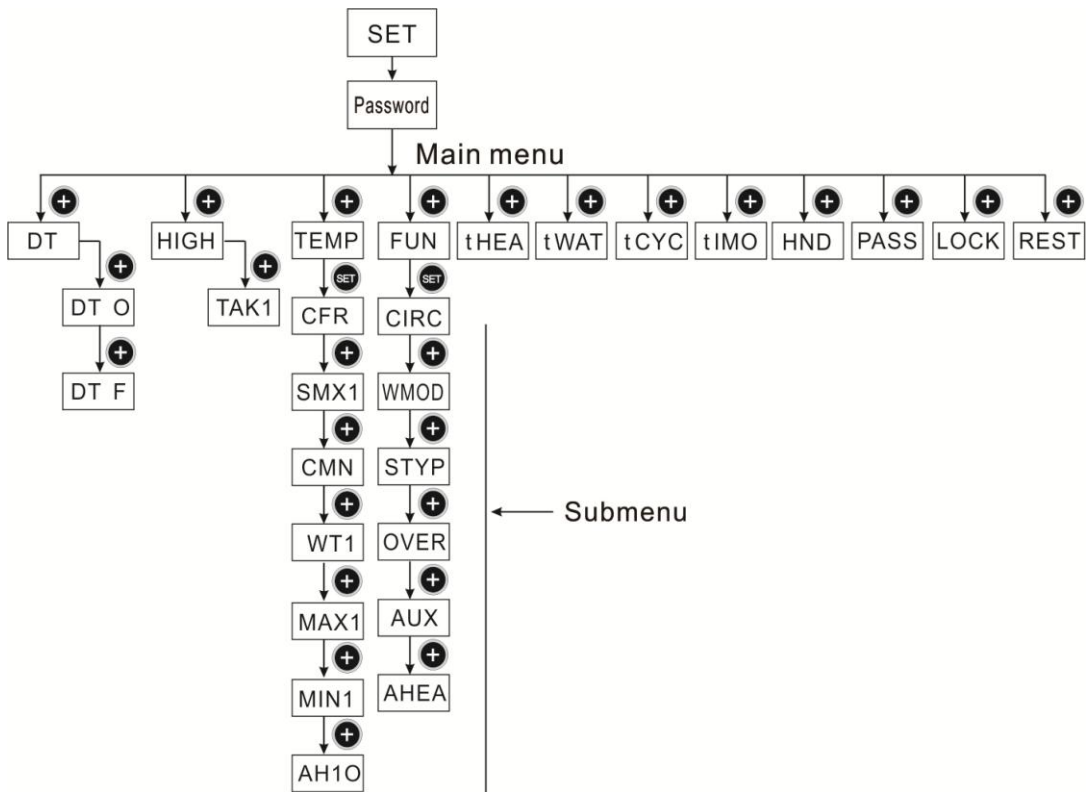

**Submenu:**

Through submenu, user can set the parameter as desired value, please check it carefully.

### 3.3 Menu description

Code (Main menu)	Code (Submenu)	Code (Submenu)	Menu Description
<b>DT</b>	DT O		Switch-on temperature difference
	DT F		Switch-off temperature difference
<b>HIGH TEMP</b>	TAK1		Water height setting of storage 1
	CFR		Frost protection of collector
	SMX1		Maximum temperature of storage
	CMN		Low temperature protection of collector
	WT1		Water loading Temperature
	MAX1		Maximum switch off temperature of floor heating (for heat transferring between storage and heating return)
	MIN1		Minimum switch-off temperature of storage ( for heat transferring between storage and heating return)
	AH1O		Switch-on temperature for self-heating tape
<b>FUN</b>			Auxiliary functions
	CIRC		Switch-on/off controlling of hot water circuit pump
	WMOD		Water loading mode
	STYP		Type of water level transmitter
	OVER		Anti-overflow protection(optional)
	AUX		Temperature difference controlling function for floor heating
	AHEA		Switch-on/off controlling of back-up heating system
<b>tHEA</b>			Setting the three time sections to control back-up heating
<b>tWAT</b>			Setting the six time sections to control storage water loading
<b>tCYC</b>			Setting the six time sections and temperature to control hot water circuit pump
<b>tIMO</b>			Three time sections setting ( timer function)
<b>HND</b>			Manual control
<b>PASS</b>			Password setting
<b>REST</b>			Recovery to factory set

## 4 System description

### System description:

Controller compares the temperature between collector (T1) and storage (T2) (bottom part), if the temperature difference (DT) rises up to the preset switch-on DT (DT<sub>on</sub>) or is over it, circuit pump R1 is triggered ; and storage is heated until DT drops to the switch-off DT(DT<sub>off</sub>) or when the storage temperature (T3) rises up to its preset maximum temperature, then circuit pump R1 is ceased.



### Back-up electrical heating control (Operation see paragraph 6.7)

Within a preset heating time section, if the storage temperature (T3) drops below the switch-on temperature of heating, then back-up electrical heating (R5) is triggered; when temperature T3 rises up to the switch-off temperature, then R5 is switched-off.

### Storage water loading control:

When water height is below the minimum water height, the water loading pump R4 is triggered to load water until water height rises up to the middle height, then pump R4 stops.

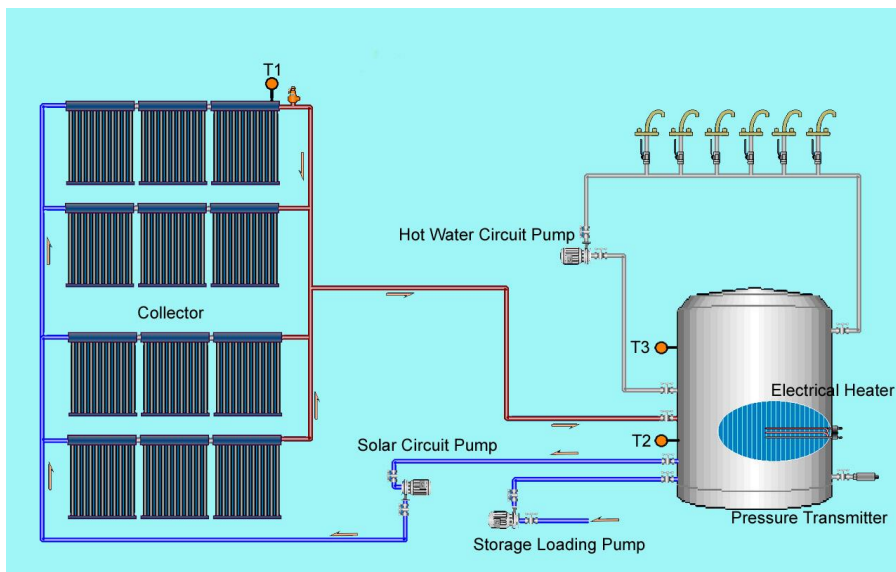

**Note:** T3 is an optional sensor, when no T3 sensor is installed in the system (no connection to input port); controller will use the signal of temperature T2 automatically to control the back-up heating or circulation.

**Inputs and outputs definition:**

Sensor	Description	Output relay	Description
T1	Sensor on the collector	R1	For solar circuit pump 1
T2	Sensor on the bottom part of storage 1	R2	For floor heating output
T3	Sensor on the upper part of storage 1 (optional)	R3	For hot water output
T4/T5	Sensor on floor heating pipe for temperature difference control	R5	For electrical back-up heater
T6	Sensor on hot water pipe	R4	For storage loading pump
T7	Sensor for triggering self heating tape	R6	For self auto heating tape
		R7	For timer output



After system installation and before setting parameter, firstly to access main menu and select “RSET” menu to recovery all parameter’s value to factory set value, and then set value of parameters user desired.

## 5. Function description and parameters setup

### 5.1 Access the main menu

Under standby status,

▶ Press “SET” button, “PWD 0000” appears, and the left digital blinks, ask for entering current password, factory set is “0000”

▶ Press “+/-” button to enter the first digital

▶ Reprress “SET” button, the second digital blinks

▶ Press “+/-” button to enter the second digital

▶ Reprress “SET” button, the third digital blinks

▶ Press “+/-” button to enter the third digital

▶ Reprress “SET” button, the fourth digital blinks

▶ Press “+/-” button to enter the fourth digital



**Note:** the factory set password is “0000”, if no new password is set, then just press “SET”

four times to access main menu.

## 5.2 DT Temperature difference

### Description:

Solar circuit pump R1 is triggered by the temperature difference function, so long as the temperature difference between collector and storage reaches the switch-on DT, solar circuit pump is triggered.

**For example:** the switch-on DT is 8°C, switch-off DT is 4°C, if the temperature on the bottom part of storage is 20°C, then just when collector temperature rises up to 28°C, pump is triggered, and when collector temperature drops to 24°C, pump is ceased.

**Note:** the switch-on/off DT of 8°C and 4°C are standard system setting according to many years' experience, only in special application cases it needs to be changed, (e.g. longer distance heat transferring), normally we recommend using default set. Switch-on and switch-off DT are alternating set. To avoid mistake the minimum difference between two temperature differences ( $\Delta T_{on} - \Delta T_{off}$ ) is set as 2°C.

### Setup temperature difference:

Under standby, access main menu DT

▶ Press “SET” button, to access settings program of main menu DT, “DT 1o 08°C” displays on screen, “08°C” blinks, the first switch-on temperature difference can be set.



▶ Press “+/-” button, to adjust the value of switch-on DT, adjustable range (OFF+2°C) ~20°C, factory setting is 8°C

▶ Press “ESC” button to exit this setting, parameter is saved automatically.

▶ Press “+” button, “DT 1F 04°C” displays on the screen, the first switch-off temperature difference can be set.



▶ Press “SET” button, “04°C” blinks

▶ Press “+/-” button to adjust the value of switch-off DT, adjustable range 0°C ~ (ON-2°C), factory set is 4°C.

▶ Press “ESC” to exit menu, or wait for 20 seconds to exit automatically, the setup parameters are saved automatically.

### 5.3 HIGH High、 Middle、 Low water position level setup

#### Description:

This menu is designed for pressure transmitter and used to set the high, middle, low water level, and with it to control the water level in tank. If you use electrode-type sensor, then menu “HIGH” will be hidden automatically.

under this menu, you can set the highest water level, middle water level and the lowest water level according to the height of water tank, and therefore to achieve the function “automatically water filling” . When the water level falls below the preset lowest water level, water filling pump will be triggered to fill water to the middle water level position.

#### TAK1 storage water height setup:

Access main menu HIGH to set water height, “HIGH” displays on the screen.

▶ Press “SET” button, parameter “TAK1” blinks on the screen.



▶ Repress “SET” button, “100CMH” the highest level displays on the screen.

▶ Repress “SET” button, “100CMH” blinks, and then press “+/-” button to set the desired highest water level.



▶ Press “ESC” button, to exit menu, parameters are saved automatically.

▶ Press “+/-” button to shift to “60CMM”: the middle water level.

▶ Repress “SET” button, “60CMM” blinks, and then press “+/-” button to set the desired middle water level.

▶ Press “ESC” button, to exit menu, parameters are saved automatically

▶ Press “+/-” button to shift to “30CML”: the lowest water level.

▶ Repress “SET” button, “30CML” blinks, and then press “+/-” button to set the desired lowest water level.

▶ Press “ESC” button, to exit menu, parameters are saved automatically.

#### Note:

- Press “+/-” button to check the water level set value.
- The middle and low water level should not higher than the height of the highest water level.

### 5.4 TEMP Temperature main menu

For a system, the factory set parameters are for the best operation condition, which is fully

integrated into the entire solar system. But these parameters can also be set individually to cater the special requirements, please carefully observe the operation data of system components after setting.

Following submenu can be access though TEMP main menu.

**Note:** Parameters that can be set rely on the whole solar system, not all the parameters can be adjusted in every solar system.

Paragraph	Tem. Code	Function of temperature	Adjustable range	Factory set
5.4.1	CFR	Frost protection of collector	-10 °C~10 °C	4 °C
5.4.2	SMX1	Maximum temperature of storage	0 °C~95 °C	60 °C
5.4.3	CMN	Low temperature protection of collector	0 °C~90 °C	10 °C
5.4.4	WT1	Water loading temperature	10 °C~95 °C	50 °C
5.4.5	MAX1	Maximum switch off temperature of floor heating (for heat transferring between storage and heating return)	(MIN1+2 °C) ~ 95 °C	60 °C
5.4.6	MIN1	Minimum switch-off temperature of storage ( for heat transferring between storage and heating return)	30 °C ~ (MAX1-2 °C)	30 °C
5.4.7	AH1O	Switch-on temperature for self-heating tape	0 °C~95 °C	---"off"

### 5.4.1 CFR frost protection of collector

#### Description:

In winter when the temperature of collector (T1) is below the preset frost protection temperature (factory set is 4 °C), solar circuit pump (R1) is triggered to transfer hot water from tank to collector and to heat collector by this reversed circuit. And when tank temperature (T2) drops to 4 °C, electrical heater is triggered automatically and it keeps running until tank temperature T2 raises up to 21 °C or it is stopped when program of CFR is exited. When collector temperature rises up to 7 °C, solar circuit pump (R1) is ceased, program of CFR exits automatically.

#### Setup steps:

To access main menu TEMP, then select submenu CFR, "CFR 04 °C" displays on the screen, default set is switch-on this function.



- ▶ Press “SET” button, default value “04°C” blinks.
- ▶ Repress “SET” button to deactivate or activate this function.



- ▶ Press “+/-” button to adjust the temperature of frost protection function, adjustable range is (-10 °C~10 °C) , after function is activated, default set is 4 °C.
- ▶ Press “ESC” button to exit the menu or wait for 20 seconds to exit automatically, parameters are saved automatically.

 CFR signal displays and blinks on the screen, it indicates that this function is activated.

### 5.4.2 SMX1 Maximum temperature of storage

#### Description:

When the DT between collector T1 and storage T2 caters the switch-on DT of circulation, solar pump is triggered, but in order to avoid the high temperature inside storage, controller will check whether the temperature (T3) of the top part of storage is higher than the maximum temperature of storage, when T3 is higher than the preset maximum storage temperature SMX, solar pump is ceased even at the case that DT caters condition. When storage temperature T3 drops and is 5°C below the SMX temperature, solar pump restarts when DT caters condition.

#### Setup steps:

To access main menu TEMP, then select submenu SMX1, “SMX1 60 °C” displays on screen.

- ▶ Press “SET” button, parameter “60 °C” blinks
- ▶ Repress “SET” button to activate and deactivate this function, if function deactivated, “SMX1 - - -” displays on the screen.



- ▶ Repress “+/-” button to adjust the value of maximum temperature of storage, adjustable range is (2 °C~95 °C) , default set is 60 °C
- ▶ Press “ESC” button to exit the menu or wait for 20 seconds to exit automatically, parameters are saved automatically.



SMX signal displays on screen, it indicates that this function is in activated.

### 5.4.3 CMN low temperature protection of collector

#### Description:

When the actual temperature of collector is below the preset CMN temperature, solar circuit pump is ceased, even when the temperature difference between collector and storage exceeds switch-on temperature difference, solar pump doesn't work yet. When the temperature of collector is 3°C higher than the preset CMN temperature, solar circuit pump is standby to work, controller exits this program.

#### Setup steps:

To access main menu TEMP, then select submenu CMN, "CMN 10°C" displays on the screen, default set is switch-on this function.



- ▶ Press "SET" button, default set "10°C" blinks on screen.
- ▶ Repress "SET" button to activate and deactivate this function.
- ▶ Press "+/-" button to adjust the low protection temperature of collector CMN, adjustable range (00°C ~ 90°C ), after activate the function, factory set is 10°C
- ▶ Press "ESC" button to exit the menu or wait for 20 seconds to exit automatically, parameters are saved automatically.



CMN signal displays on screen, it indicates that this function is activated.

### 5.4.4 WT1 Water Loading Temperature

#### Description:

If select water loading through collector mode, temperature is controlled by collector temperature T1, when T1 is higher than the preset water loading temperature, water load pump is triggered, when T1 is 5°C below the preset load temperature, loading pump is ceased. If the collector temperature T1 is always higher than the load temperature, then when water level rises up to the highest position, load pump is ceased.

If select water loading through storage mode, temperature is controlled by storage temperature T3, when T3 is higher than the preset water loading temperature, water load

pump is triggered, water is pumped into storage and T3 temperature drops, when T3 is 5°C below the preset load temperature, loading pump is ceased. If the storage temperature T3 is always higher than load temperature, then when water level rises up to the highest position, load pump is ceased.

Temperature controlled water filling function will not be triggered due to no enough solar irradiation, but when water level falls below the 25% position due to large water using, then water filling pump will be triggered immediately to fill water up to the 75% position.

### Setup steps:

To access main menu TEMP, then select submenu WT1, “WT1 --” displays on the screen, default set is switch-off this function.

▶ Press “SET” button, default off signal “- - -” blinks on the screen.



▶ Repress “SET” button to activate and deactivate this function.

▶ Press “+/-” button to adjust the water loading temperature, adjustable range (10 °C ~95 °C ), after activate the function, factory set is 50 °C

▶ Press “ESC” button to exit the menu or wait for 20 seconds to exit automatically, parameters are saved automatically.

**Note:** if load water through collector, then take the collector temperature T1 to control water loading.



WT1 signal displays on screen, it indicates that this function is activated.

### 5.4.5 MAX1 Maximum switch off temperature of floor heating (for heat transferring between storage and heating return)

Description:

This function provides possibility that through temperature adjustment to control circuit pump, it makes storage is heated by back-up boiler. In the case that the temperature of upper part of storage drops the preset switch-on temperature or boiler temperature is between its “MIN1” and “MAX1”, circuit pump is triggered ( AUX). When storage temperature rises up to or above the preset switch-off temperature or boiler temperature is outside the range of “MIN1” and “MAX1”, then circuit pump is ceased.

### Setup steps:

To access main menu TEMP, then select submenu MAX1, "MAX1 60°C" displays on the screen.

▶ Press "SET" button, default value "60°C" blinks on the screen.

▶ Press "+/-" button to adjust the maximal switch-off temperature, adjustable range (MIN1 +2°C ~95°C), factory set is 60°C.

▶ Press "ESC" button to exit the menu or wait for 20 seconds to exit automatically, parameters are saved automatically.



### 5.4.6 MIN1 Minimum switch on temperature of storage (for heat transferring between storage and heating return)

#### Setup steps:

To access main menu TEMP, then select submenu MIN1, "MIN1 30°C" displays on the screen.

▶ Press "SET" button, default value "30°C" blinks on the screen.

▶ Press "+/-" button to adjust the minimum switch-on temperature, adjustable range 30°C ~ (MAX1-2°C), factory set is 30°C.

▶ Press "ESC" button to exit the menu or wait for 20 seconds to exit automatically, parameters are saved automatically.



### 5.4.7 AH10 Switch-on temperature for self-heating tape

#### Description:

In winter, outdoor ambient temperature is lower, in order to prevent water pipe from freezing, when detect the pipe temperature T7 is below the switch-on temperature of self-heating tape(AH10), then self-heating tape( R6) is powered to heat water pipe, and power of self heating tape is switched off until T7 rises up to the switch-off temperature ( AH1F).

If set the switch-on temperature AH10 is 2°C and switch-off temperature is 5°C, then when

T7 temperature drops to 2°C, self heating tape is switched-on, when T7 rises up to 5°C, then switch-off the self heating tape.

### Setup steps:

To access main menu TEMP, then select submenu AH10, “AH10 --” displays on the screen, default set is switch-off this function.

▶ Press “SET” button, default “AH10 - - -” blinks on the screen.

▶ Press “+/-” button to adjust the switch-on temperature, adjustable range (0 °C ~95 °C ).

▶ Press “ESC” button to exit the menu

▶ Press “+” button, default “AH1F 05°C” blinks on the screen.

▶ Press “+/-” button to adjust the switch-off temperature, adjustable range (0 °C ~95 °C ).

▶ Press “ESC” button to exit the menu or wait for 20 seconds to exit automatically, parameters are saved automatically.



 **Note:** When this signal appears on the screen, it means self-heating tape is working.

## 5.5 FUN Auxiliary function

Auxiliary functions can be set under “FUN” menu; several functions can be activated at the same time. Following submenu can be accessed under “FUN” menu.

5.5.1	CIRC	Switch-on/off control of hot water circuit pump
5.5.2	WMOD	Water loading mode
5.5.3	STYP	Type of water level transmitter
5.5.4	OVER	Anti-overflow protection(optional)
5.5.5	AUX	Temperature difference control function for floor heating
5.5.6	AHEA	Switch-on/off control of back-up heating system

### 5.5.1 CIRC Switch-on/off control of hot water circuit pump

#### Description:

Solar system can provide temperature-controlled hot water circulation function; this

function needs an extra hot water circulation pump (connect output port R3) and a sensor, which is installed on the return pipe of hot water (connect input port T6). When the temperature signal of sensor T6 is less than the preset turning on temperature of DHW pump, the hot water circulation pump (R3) triggers and works till the temperature exceeds the turning off temperature.

**Condition for triggering hot water circulation pump:**

Only when tank temperature T3 is 3°C higher than the preset switch-on temperature, hot water circulation pump just can be triggered. When sensor T3 ( upper part of tank ) is not installed, then controller will take the sensor T2 temperature to control circulation pump R3.

**Note:**

In order to avoid large measuring error, the sensor T6 on hot water return pipe should be installed 1.5m far away from tank.

**Setup steps:**

To access main menu FUN, then select submenu CIRC, “CIRC OFF” displays on the screen, default set is switch-off this function.

- ▶ Press “SET” button, default “OFF” blinks on the screen.
- ▶ Repress “SET” button to activate this function. “CIRC ON” appears on the screen.
- ▶ Press “ESC” button to exit the menu or wait for 20 seconds to exit automatically, parameters are saved automatically.



**5.5.2 WMOD Water loading mode**

**Description:**

Solar system has 2 modes to load water, one is load through storage, the other one is through collector, it can be set by user, select “00” means loading through storage, select “01” means loading through collector

**Setup steps:**

To access main menu FUN, then select submenu WMOD, “WMOD 00” displays on the screen, default set is “00”

- ▶ Press “SET” button, default “00” blinks on the screen.

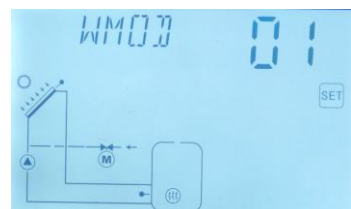

- ▶ Press “+/-” button, to select the loading mode.
- ▶ Press “ESC” button to exit the menu or wait for 20 seconds to exit automatically, parameters are saved automatically.

### 5.5.3 STYP selecting the type of the water level sensor

Description:

Three types water level sensor can be selected:

STYP 00: Electrode water level sensor.

STYP01: Pressure transmitter.

STYP02: Grundfos pressure sensor.



Select STYP submenu, “STYP 00” displays on the screen, factory set: 00

- Press “SET” button, parameter “00” blinks on the screen
- Press “+/-” to select the type of sensor
- Press “ESC” to exit menu or wait for 20s to exit automatically (set parameter is saved automatically)

- “00” electrode water level sensor

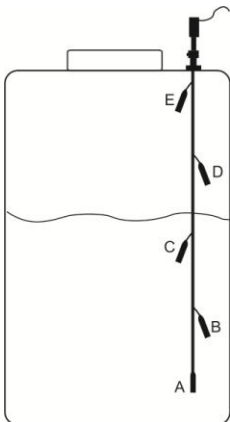

- “01” pressure transmitter

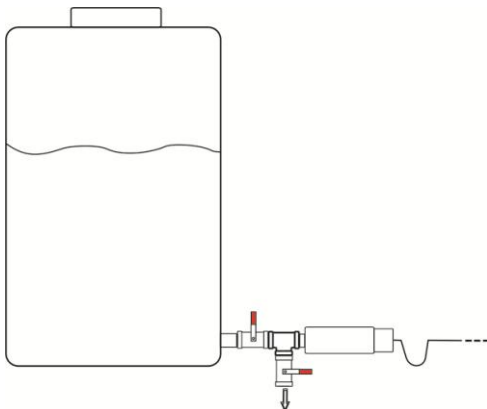

- “02” Grundfos pressure sensor

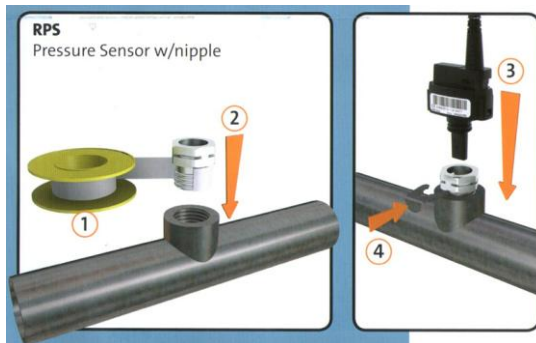

### 5.5.4 OVER anti overflow protection function (optional)

Description:

A extra floating device can be installed on the top of solar tank ( connect terminal port “K”), when water level rises to the position of this floating device, then the contact switch of floating device is open to stop the water filling pump.

Note: please purchase the floating device which is similar to the showed picture ( always close).

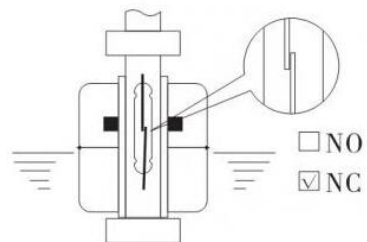

Setting:

Select OVER submenu, “OVER OFF” displays on the screen, factory set: close.

- Press “SET” button, “OVER OFF” blinks on the screen.
- Press “SET” again to make this function available, “OVER ON” displays on the screen.
- Press “ESC” to exit menu or wait for 20s to exit automatically (set parameter is saved automatically)





### 5.5.5 AUX Temperature difference control function for floor heating

#### Description:

This temperature difference is used to control the temperature of storage and the temperature of the floor heating return. When the temperature difference(DT2) between storage temperature T4 and floor heating return temperature T5 caters the switch-on DT2O, then circuit pump R2 is triggered to heat floor heating return; When the temperature difference(DT2) between storage temperature T4 and floor heating return temperature T5 drops to the switch-off DT2F, then circuit pump R2 is ceased.

#### Activate and deactivate this function:

To access main menu FUN, then select submenu AUX, "AUX OFF" displays on the screen, default set is "OFF"

▶ Press "SET" button, default "AUX OFF" blinks on the screen.

▶ Repress "SET" button, to activate this function, "AUX ON" displays on the screen.

▶ Press "ESC" button to exit the menu or wait for 20 seconds to exit automatically, parameters are saved automatically.



When this signal appears on the screen, it means floor heating temperature difference control function is working.

**Note :** After activating the floor heating temperature difference control function, the switch-on/off temperature difference can be set at "DT 2O" submenu, and under the "TEMP" menu, at "MAX1" "MIN1" submenu, the maximum switch-off temperature of floor heating (T5) and the minimum switch-on temperature of storage (T4) can be set.

Application example:

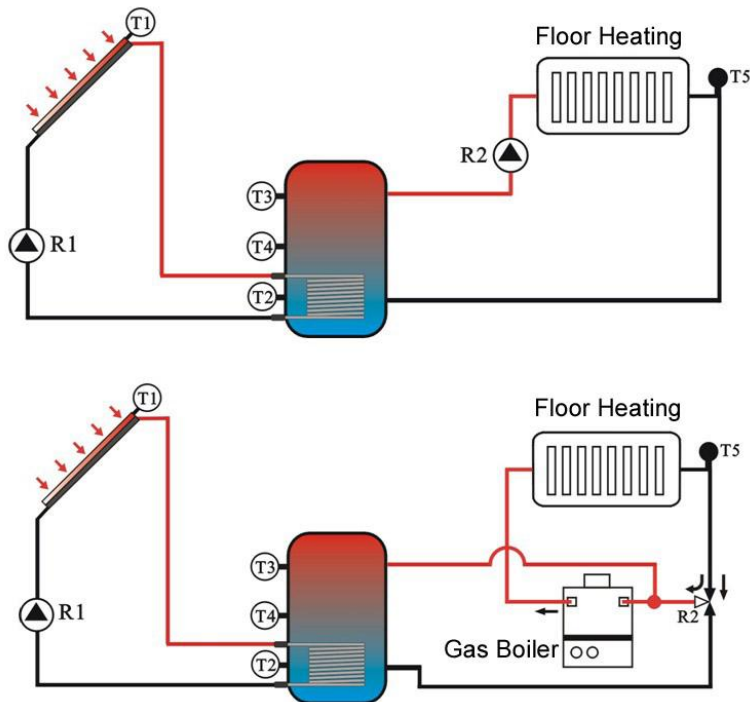

**5.5.6 AHEA Switch-on/off control of back-up heating system**

Description:

This controller can ensure to provide enough hot water in the case that solar energy isn't enough, solar system is designed to combine with traditional devices like electrical heater, gas or oil boiler etc, this controller can control to trigger those devices, when the temperature of upper part of storage is lower than the default switch-on temperature, the back-up heating devices will be triggered, and when the temperature of upper part of storage rises up to the default switch-off temperature, the back-up heating devices is ceased to heat. There are 5 default heating time sections every day.

Factory default set:

The first heating time starts at 12:00 and stops when the temperature rises up to 30°C;  
 The second heating time starts at 13:00 and stops when the temperature rises up to 35°C;  
 The third heating time starts at 14:00 and stops when the temperature rises up to 40°C;  
 The fourth heating time starts at 15:00 and stops when the temperature rises up to 45°C;  
 The fifth heating time starts at 16:00 and stops when the temperature rises up to 50°C.

### Setup steps:

To access main menu FUN, then select submenu AHEA, "AHEA ON" displays on the screen, default set is "ON"



▶ Press "SET" button, default "ON" blinks on the screen.

▶ Repress "SET" button, to deactivate this function, "AHEA OFF" displays on the screen.

▶ Press "ESC" button to exit the menu or wait for 20 seconds to exit automatically, parameters are saved automatically.

**Note:** Time sections and temperature is defaulted parameters, it is impossible to reset, user can just select to activate or deactivate this function.

## 5.6 tHEA Timing heating

### Description:

Electrical heater, gas boiler or oil boiler can be integrated into solar system used as back-up of system, and they can be triggered automatically at preset schedule by preset temperature. Within a preset schedule, when the temperature (T3) of top part of tank drops below the preset switching-on temperature of this function, back-up heating starts to work, when T3 rises up to the preset turning off temperature, back-up heating is stopped. Within 24 hours, three time sections can be set with this controller.

### Factory set:

The first schedule: back-up heating function starts at 4:00 and ends at 5:00 am. Within this time section, switch-on temperature is 40°C; switch-off temperature is 45°C.

The second schedule: from 10:00 to 10:00 am, it means there is no back-up heating in this time.

The third schedule: back-up heating function starts at 17:00 and ends at 22:00 pm. Within this time section, the switch-on temperature is 50°C; switch-off temperature is 55°C.

The switch-on temperature of heating adjustable range: 3 °C ~ (OFF-2 °C).

The switch-off temperature of heating adjustable range: (ON+2 °C) ~ 80 °C.

If you want to shut off one timing heating, then you can set the turning on time and turning off time same value (for example, the second time section no this function, then you can set turning on/off time is 10:00 ~ 10:00).

When time is outside of the preset schedule, back-up heating doesn't work automatically even when the tank temperature reaches the switch –on temperature of heating.

**Note:**

- When there is no sensor installed in the top part of tank (no T3 sensor), controller will take the signal of T2 (sensor in bottom of tank) automatically to control this function.
- The time in this controlled is 24 hours, when you set schedule, the switch-off time of heating should be larger than switch-on time. For example: if you set the switch-on time of heating is at 17:00, but switch-off time of heating is 6:00, then this setting doesn't take effect, that means within this time section, heating function doesn't work. The correct set is like flowing: it should be divided into two time sections, one time section is from 17:00 to 23:59, the other time section is from 00:00 to 06:00.

**Setup steps:**

To access main menu tHEA, "tHEA" displays on the screen.

▶ Press button "SET" to access tHEA program to set parameter, "tH 1O 04:00" displays on screen, the switch-on time and temperature for the first schedule of heating function can be set.



▶ Press "SET" button, "04" of hour time blinks on screen

▶ Press "+" "-" button to adjust hour of time

▶ Repress "SET" button again, "00" of minute time blinks on screen

▶ Press "+" "-" button to adjust minute of time

▶ Repress "SET" button, temperature "40°C" blinks on screen



▶ Press "+" "-" button, to set the switch-on temperature of heating

▶ Then, Press "ESC" to exit this set

▶ Press button "+", "tH 1F 05:00" displays on screen, the switch-off time and temperature for the first schedule of heating function can be set.

▶ Press "SET" button, "05" of hour time blinks on screen.

▶ Press "+" "-" button to adjust hour of time

▶ Repress "SET" button, "00" of minute time blinks on screen

▶ Press "+" "-" button to set minute of time

- ▶ Repress “SET” button, temperature “45°C” blinks on screen
- ▶ Press “+”“-” button, to set switch-off temperature of heating
- ▶ Press “ESC” to exit this set program, or wait for 20 seconds to exit automatically, parameters are saved automatically.

-----

▶ Press button “+”, “tH 2O 10:00” displays on the screen, the switch-on time and temperature for the second schedule of heating function can be set.

- ▶ Press “SET” button, “10” of hour time blinks on the screen
- ▶ Press “+”“-” button to adjust hour of time
- ▶ Repress “SET” button again, “00” of minute time blinks on the screen
- ▶ Press “+”“-” button to adjust minute of time
- ▶ Repress “SET” button, temperature “50°C” blinks on screen



- ▶ Press “+”“-” button, to set the switch-on temperature of heating
- ▶ Then, Press “ESC” to exit this set

▶ Press button “+”, “tH 2F 10:00” displays on screen, the switch-off time and temperature for the second schedule of heating function can be set.

- ▶ Press “SET” button, “10” of hour time blinks on screen.
- ▶ Press “+”“-” button to adjust hour of time
- ▶ Repress “SET” button, “00” of minute time blinks on screen
- ▶ Press “+”“-” button to set minute of time



- ▶ Repress “SET” button, temperature “55°C” blinks on screen
- ▶ Press “+”“-” button, to set switch-off temperature of heating
- ▶ Press “ESC” to exit this set program, or wait for 20 seconds to exit automatically, parameters are saved automatically.

-----

▶ Press button “+”, “tH 3O 17:00” displays on the screen, the switch-on time and temperature for the third schedule of heating function can be set.

- ▶ Press “SET” button, “17” of hour time blinks on screen
- ▶ Press “+”“-” button to adjust hour of time
- ▶ Repress “SET” button again, “00” of minute time blinks on screen
- ▶ Press “+”“-” button to adjust minute of time





- ▶ Repress “SET” button, temperature “50°C” blinks on screen
- ▶ Press “+”“-” button, to set the switch-on temperature of heating
- ▶ Then, Press “ESC” to exit this set

▶ Press button “+”, “tH 3F 22:00” displays on screen, the switch-off time and temperature for the third schedule of heating function can be set.

- ▶ Press “SET” button, “22” of hour time blinks on screen.
- ▶ Press “+”“-” button to adjust hour of time
- ▶ Repress “SET” button, “00” of minute time blinks on screen



- ▶ Press “+”“-” button to set minute of time
- ▶ Repress “SET” button, temperature “55°C” blinks on screen
- ▶ Press “+”“-” button, to set switch-off temperature of heating
- ▶ Press “ESC” to exit this set program, or wait for 20 seconds to exit automatically, parameters are saved automatically

**Note:** when no gas or oil boiler is connected to the solar system, electrical heater can be installed as back-up device, in this case, signal  will displays on the screen, and when electrical heater is in operation status, signal  blinks on screen.

## 5.7 tWAT Timing Water Loading

### Description:

According to the preset time and water level, water of solar system is filled to the preset water level at the preset time ( 4 preset water levels can be set: 25%,50%,75% and 100%). Within a day, 6 time periods can be set for filling water.

- If pressure transmitter is selected to measure the water level, then the “CM” is used as the measure unit of water level in menu.
- If electrode sensor is selected to measure the water level, then “%” is used as the measure unit in the menu like 25%, 50%, 75%, 100% etc.

During the non water filling time period, lack of water in tank may be happened when large volume water is used (water level is less than 25%), in this case, controller will activate the water filling function automatically and fill water up to the 75% position.

### Setup steps:

To access main menu tWAT, “tWAT” displays on the screen.

▶ Press button “SET” to access tWAT program to set parameter, “tW1 00:00” displays on the screen, the switch-on time of the first schedule of water loading function can be set.

▶ Press “SET” button, “00” of hour time blinks on the screen

▶ Press “+”“-” button to adjust hour of time

▶ Press “SET” button, “00” of minute time blinks on the screen

▶ Press “+”“-” button to adjust minute of time

▶ Press “SET” button, “30CM” water level blinks on the screen

▶ Press “+”“-” button to adjust preset water level.

▶ Then, press “ESC” to exit this set



-----  
▶ Press button “+”, “tW2 00:00” displays on the screen, the switch-on time and water level for the second schedule of water loading function can be set.

▶ Press “SET” button, “00” of hour time blinks on the screen

▶ Press “+”“-” button to adjust hour of time

▶ Press “SET” button, “00” of minute time blinks on the screen

▶ Press “+”“-” button to adjust minute of time

▶ Press “SET” button, “30CM” water level blinks on the screen

▶ Press “+”“-” button to adjust preset water level.

▶ Then, press “ESC” to exit this set, or wait for 20 seconds to exit automatically, parameters are saved automatically



-----  
▶ Press button “+”, “tW3 00:00” displays on the screen, the switch-on time and water level for the third schedule of water loading function can be set.

▶ Press “SET” button, “00” of hour time blinks on the screen

▶ Press “+”“-” button to adjust hour of time

▶ Press “SET” button, “00” of minute time blinks on the screen

▶ Press “+”“-” button to adjust minute of time

▶ Press “SET” button, “30CM” water level blinks on the screen

▶ Press “+”“-” button to adjust preset water level.

▶ Then, press “ESC” to exit this set.



-----  
▶ Press button “+”, “tW4 00:00” displays on the screen, the switch-on time and water level

for the fourth schedule of water loading function can be set.

▶ Press “SET” button, “00” of hour time blinks on the screen

▶ Press “+”“-” button to adjust hour of time

▶ Press “SET” button, “00” of minute time blinks on the screen

▶ Press “+”“-” button to adjust minute of time

▶ Press “SET” button, “30CM” water level blinks on the screen

▶ Press “+”“-” button to adjust preset water level.

▶ Then, press “ESC” to exit this set, or wait for 20 seconds to exit automatically, parameters are saved automatically.



-----  
▶ Press button “+”, “tW5 00:00” displays on the screen, the switch-on time and water level for the fifth schedule of water loading function can be set.

▶ Press “SET” button, “00” of hour time blinks on the screen

▶ Press “+”“-” button to adjust hour of time

▶ Press “SET” button, “00” of minute time blinks on the screen

▶ Press “+”“-” button to adjust minute of time

▶ Press “SET” button, “30CM” water level blinks on the screen

▶ Press “+”“-” button to adjust preset water level.

▶ Then, press “ESC” to exit this set



-----  
▶ Press button “+”, “tW6 00:00” displays on the screen, the switch-on time and water level for the sixth schedule of water loading function can be set.

▶ Press “SET” button, “00” of hour time blinks on the screen

▶ Press “+”“-” button to adjust hour of time

▶ Press “SET” button, “00” of minute time blinks on the screen

▶ Press “+”“-” button to adjust minute of time

▶ Press “SET” button, “30CM” water level blinks on the screen

▶ Press “+”“-” button to adjust preset water level.

▶ Then, Press “ESC” to exit this set, or wait for 20 seconds to exit automatically, parameters are saved automatically.





## 5.8 tCYC Time or Temperature controlled DHW pump

### Description:

Solar system can provide time or temperature-controlled hot water circulation(DHW) function; this function needs an extra hot water circulation pump (connect output port R3) and a sensor, which is installed on the return pipe of hot water (connect input port T6). When the temperature signal of sensor T6 is less than the preset turning on temperature of DHW pump, the hot water circulation pump (R3) triggers and works till the temperature exceeds the turning off temperature.

### Triggering condition for temperature controlled DHW hot water circulation pump:

only when tank temperature T3 is 1°C higher than the preset switch-off hot water temperature, hot water circulation pump just can be triggered. (If sensor T3 isn't installed, controller will take signal from T2 to control this function).

### Description of time controlled DHW pump:

DHW pump can also be controlled at the preset schedule, this function needs an extra DHW pump (connect output port R3), this pump will be timing triggered, and within a running time section, default operation is pump runs for 3 minutes, then stops for 15 minutes, the process repeats within the time section.

### Default time sections:

The first time section: pump works at 04:00 and stops at 05:00.

The second time section: pump works at 10:00 and stops at 10:00.

The third time section: pump works at 17:00 and stops at 22:00.

The fourth time section: pump works at 10:00 and stops at 00:00.

The fifth time section: pump works at 10:00 and stops at 00:00.

The sixth time section: pump works at 10:00 and stops at 00:00.

If user wants to switch-off any time section, then just set the start time and close time with same time, e.g. starts at 10:00 and close also at 10:00.

### Note:

- Temperature controlled DHW function is prior to time controlled DHW.
- When T6 is installed on the return pipe of hot water, controller will automatically turn-off the time controlled function, inverse to use temperature control DHW.
- TCYC program just provide the triggering temperature or time to run DHW, it doesn't mean this function is activated. Whether this function is available to use should be

selected under menu FUN/CIRC. Therefore, please access main menu FUN, select CIRC submenu and activate this function there.

- In order to avoid large measuring error, the sensor T6 on hot water return pipe should be installed 1.5m far away from tank.

**Setup steps:**

To access main menu tCYC, "tCYC" displays on the screen.

▶ Press button "SET", access the set program of "tCYC", "tC 1O 04:00" displays on the screen, the switch-on time for the first schedule of DHW pump function can be set.

- ▶ Press "SET" button, "04" of hour time blinks on screen
- ▶ Press "+" "-" button to adjust hour of time
- ▶ Re-press "SET" button, "00" of minute time blinks on screen
- ▶ Press "+" "-" button to adjust minute of time
- ▶ Re-press "SET" button, time "03MIN" blinks on screen
- ▶ Press "+" "-" button, to set the running time of DHW pump.
- ▶ Then, press "ESC" to exit this set



▶ Press button "+", "tC 1F 05:00" displays on screen, the switch-off time for the first schedule of DHW pump function can be set.

- ▶ Press "SET" button, "05" of hour time blinks on screen.
- ▶ Press "+" "-" button to adjust hour of time
- ▶ Re-press "SET" button, "00" of minute time blinks on screen
- ▶ Press "+" "-" button to set minute of time,
- ▶ Re-press "SET" button, time "15MIN" blinks on screen
- ▶ Press "+" "-" button, to set the interval time of DHW pump.
- ▶ Press "ESC" to exit this set program, or wait for 20 seconds to exit automatically, parameters are saved automatically



-----  
▶ Press button "+", "tC 2O 10:00" displays on screen, the switch-on time for the second schedule of DHW pump function can be set.

- ▶ Press "SET" button, "10" of hour time blinks on screen.
- ▶ Press "+" "-" button to adjust hour of time
- ▶ Re-press "SET" button, "00" of minute time blinks on screen



- ▶ Press “+”“-” button to set minute of time ,
- ▶ Reprer “SET” button, time“03MIN” blinks on screen
- ▶ Press “+”“-” button, to set the running time of DHW pump.
- ▶ Press “ESC” to exit this set program

▶ Press button “+”, “tC 2F 10:00”displays on screen, the switch-off time for the second schedule of DHW pump function can be set.



- ▶ Press “SET” button, “10” of hour time blinks on screen.
- ▶ Press “+”“-” button to adjust hour of time
- ▶ Reprer “SET” button, “00” of minute time blinks on screen

- ▶ Press “+”“-” button to set minute of time ,
- ▶ Reprer “SET” button, time“15MIN” blinks on screen
- ▶ Press “+”“-” button, to set the interval time of DHW pump.
- ▶ Press “ESC” to exit this set program, or wait for 20 seconds to exit automatically, parameters are saved automatically

-----  
▶ Press button “+”, “tC 3O 17:00” displays on screen, the switch-on time for the third schedule of DHW pump function can be set.



- ▶ Press “SET” button, “17” of hour time blinks on screen.
- ▶ Press “+”“-” button to adjust hour of time
- ▶ Reprer “SET” button, “00” of minute time blinks on screen

- ▶ Press “+”“-” button to set minute of time ,
- ▶ Reprer “SET” button, time“03MIN” blinks on screen
- ▶ Press “+”“-” button, to set the running time of DHW pump.
- ▶ Press “ESC” to exit this set program

▶ Press button “+”, “tC 3F 22:00”displays on screen, the switch-off time for the third schedule of DHW pump function can be set.



- ▶ Press “SET” button, “22” of hour time blinks on screen.
- ▶ Press “+”“-” button to adjust hour of time
- ▶ Reprer “SET” button, “00” of minute time blinks on screen

- ▶ Press “+”“-” button to set minute of time ,
- ▶ Reprer “SET” button, time“15MIN” blinks on screen

- ▶ Press “+”“-” button, to set the interval time of DHW pump.
- ▶ Press “ESC” to exit this set program, or wait for 20 seconds to exit automatically, parameters are saved automatically

-----  
▶ Press button “+”, “tC 4O 00:00” displays on screen, the switch-on time for the fourth schedule of DHW pump function can be set.

- ▶ Press “SET” button, “00” of hour time blinks on screen.
- ▶ Press “+”“-” button to adjust hour of time
- ▶ Re-press “SET” button, “00” of minute time blinks on screen



- ▶ Press “+”“-” button to set minute of time,
- ▶ Re-press “SET” button, time “03MIN” blinks on screen
- ▶ Press “+”“-” button, to set the running time of DHW pump.
- ▶ Press “ESC” to exit this set program,

▶ Press button “+”, “tC 4F 00:00” displays on screen, the switch-off time for the fourth schedule of DHW pump function can be set.

- ▶ Press “SET” button, “00” of hour time blinks on screen.
- ▶ Press “+”“-” button to adjust hour of time
- ▶ Re-press “SET” button, “00” of minute time blinks on screen



- ▶ Press “+”“-” button to set minute of time,
- ▶ Re-press “SET” button, time “15MIN” blinks on screen
- ▶ Press “+”“-” button, to set the interval time of DHW pump.
- ▶ Press “ESC” to exit this set program, or wait for 20 seconds to exit automatically, parameters are saved automatically

-----  
▶ Press button “+”, “tC 5O 00:00” displays on screen, the switch-on time for the fifth schedule of DHW pump function can be set.

- ▶ Press “SET” button, “00” of hour time blinks on screen.
- ▶ Press “+”“-” button to adjust hour of time
- ▶ Re-press “SET” button, “00” of minute time blinks on screen



- ▶ Press “+”“-” button to set minute of time,
- ▶ Re-press “SET” button, time “03MIN” blinks on screen
- ▶ Press “+”“-” button, to set the running time of DHW pump.

- ▶ Press “ESC” to exit this set program,
- ▶ Press button “+”, “tC 5F 00:00” displays on screen, the switch-off time for the fifth schedule of DHW pump function can be set.
- ▶ Press “SET” button, “00” of hour time blinks on screen.
- ▶ Press “+”“-” button to adjust hour of time
- ▶ Repress “SET” button, “00” of minute time blinks on screen
- ▶ Press “+”“-” button to set minute of time,
- ▶ Repress “SET” button, time “15MIN” blinks on screen
- ▶ Press “+”“-” button, to set the interval time of DHW pump.
- ▶ Press “ESC” to exit this set program, or wait for 20 seconds to exit automatically, parameters are saved automatically



- 
- ▶ Press button “+”, “tC 6O 00:00” displays on screen, the switch-on time for the sixth schedule of DHW pump function can be set.
  - ▶ Press “SET” button, “00” of hour time blinks on screen.
  - ▶ Press “+”“-” button to adjust hour of time
  - ▶ Repress “SET” button, “00” of minute time blinks on screen
  - ▶ Press “+”“-” button to set minute of time,
  - ▶ Repress “SET” button, time “03MIN” blinks on screen
  - ▶ Press “+”“-” button, to set the running time of DHW pump.
  - ▶ Press “ESC” to exit this set program,



- ▶ Press button “+”, “tC 6F 00:00” displays on screen, the switch-off time for the sixth schedule of DHW pump function can be set.
- ▶ Press “SET” button, “00” of hour time blinks on screen.
- ▶ Press “+”“-” button to adjust hour of time
- ▶ Repress “SET” button, “00” of minute time blinks on screen
- ▶ Press “+”“-” button to set minute of time,
- ▶ Repress “SET” button, time “15MIN” blinks on screen
- ▶ Press “+”“-” button, to set the interval time of DHW pump.
- ▶ Press “ESC” to exit this set program, or wait for 20 seconds to exit automatically, parameters are saved automatically.



**Note:** Above steps are for setting the 6 schedules of DHW pump, for setting temperature,

steps are same like above.

## 5.9 tIMO Timer function

### Timer setting

Description: through the timer function of the controller, the output port R7 can be triggered timing. With the time section, this output is available, outside the timer section, R7 is unavailable.

#### Setup steps:

To access main menu tIMO, "tIMO" displays on the screen.

▶ Press button "SET", access the set program of "tIMO", "tM1O 00:00" displays on the screen, the switch-on time for the first schedule of R7 output can be set.

- ▶ Press "SET" button, "00" of hour time blinks on screen
- ▶ Press "+" "-" button to adjust hour of time
- ▶ Repress "SET" button, "00" of minute time blinks on screen
- ▶ Press "+" "-" button to adjust minute of time
- ▶ Then, Press "ESC" to exit this set



▶ Press button "+", "tM1F 00:00" displays on the screen, the switch-off time for the first schedule of R7 output can be set.

- ▶ Press "SET" button, "00" of hour time blinks on screen
- ▶ Press "+" "-" button to adjust hour of time
- ▶ Repress "SET" button, "00" of minute time blinks on screen
- ▶ Press "+" "-" button to adjust minute of time
- ▶ Then, Press "ESC" to exit this set, or wait for 20 seconds to exit automatically, parameters are saved automatically.



-----  
▶ Press button "+", "tM2O 00:00" displays on the screen, the switch-on time for the second schedule of R7 output can be set.

- ▶ Press "SET" button, "00" of hour time blinks on screen
- ▶ Press "+" "-" button to adjust hour of time
- ▶ Repress "SET" button, "00" of minute time blinks on screen



▶ Press “+”“-” button to adjust minute of time

▶ Then, Press “ESC” to exit this set

▶ Press button “+”, “tM2F 00:00” displays on the screen, the switch-off time for the second schedule of R7 output can be set.

▶ Press “SET” button, “00” of hour time blinks on screen

▶ Press “+”“-” button to adjust hour of time

▶ Re-press “SET” button, “00” of minute time blinks on screen

▶ Press “+”“-” button to adjust minute of time

▶ Then, Press “ESC” to exit this set,



-----  
▶ Press button “+”, “tM3O 00:00” displays on the screen, the switch-on time for the third schedule of R7 output can be set.

▶ Press “SET” button, “00” of hour time blinks on screen

▶ Press “+”“-” button to adjust hour of time

▶ Re-press “SET” button, “00” of minute time blinks on screen

▶ Press “+”“-” button to adjust minute of time

▶ Then, Press “ESC” to exit this set



▶ Press button “+”, “tM3F 00:00” displays on the screen, the switch-off time for the third schedule of R7 output can be set.

▶ Press “SET” button, “00” of hour time blinks on screen

▶ Press “+”“-” button to adjust hour of time

▶ Re-press “SET” button, “00” of minute time blinks on screen

▶ Press “+”“-” button to adjust minute of time

▶ Then, Press “ESC” to exit this set,



### **5.10 HND Manual mode**

When using this controller first time or when debugging this controller, output of this controller (R1, R2, R3, R4, R5,R6,R7,) can be triggered manually. Manually “On, OFF” control.

#### **Setup steps:**

To access main menu HND,

▶ Press “SET” button, “HND1 off” displays on the screen, R1 output can be manually set.

▶ Press “SET” button, “HND1 on” displays on the screen, R1 output is switched-on.

▶ Press “SET” again, “HND1 off” displays, R1 output is switched-off.

▶ Press “ESC” to exit R1 set program.



---

▶ Press “+” button, “HND2 off” displays on the screen, R2 output manually set

▶ Press “SET” button, “HND2on” displays on the screen, R2 output is switched-on

▶ Press “SET” again, “HND2off” displays, R2 output is switched-off

▶ Press “ESC” to exit R2 set program



---

▶ Press “+” button, “HND3 off” displays on the screen, R3 output manually set

▶ Press “SET” button, “HND3 on” displays on the screen, R3 output is switched-on

▶ Press “SET” again, “HND3 off” displays, R3 output is switched-off

▶ Press “ESC” to exit R3 set program



---

▶ Press “+” button, “HND4 off” displays on the screen, R4 output manually set

▶ Press “SET” button, “HND4 on” displays on the screen, R4 output is switched-on

▶ Press “SET” again, “HND4 off” displays, R4 output is switched-off

▶ Press “ESC” to exit R4 set program



---

▶ Press “+” button, “HND5 off” displays on the screen, R5 output manually set

▶ Press “SET” button, “HND5 on” displays on the screen, R5 output is switched-on

▶ Press “SET” again, “HND5 off” displays, R5 output is switched-off

▶ Press “ESC” to exit R5 set program





▶ Press “+” button, “HND6 off” displays on the screen, R6 output manually set

▶ Press “SET” button, “HND6 on” displays on the screen, R6 output is switched-on

▶ Repress “SET” again, “HND6 off” displays, R6 output is switched-off

▶ Press “ESC” to exit R6 set program



▶ Press “+” button, “HND7 off” displays on the screen, R7 output manually set

▶ Press “SET” button, “HND7 on” displays on the screen, R7 output is switched-on

▶ Repress “SET” again, “HND7 off” displays, R7 output is switched-off

▶ Press “ESC” to exit R7 set program



**Note:** when manual mode is activated,  signal displays on the screen, after 15 minutes all outputs are switched-off, controller exits manual mode automatically.

### 5.11 PASS Password setting

#### Setup steps:

To access main menu “PASS.”

▶ Press “SET” button, “PWDC 0000”, the left digital blinks, ask for to enter the password, factory set is “0000”

▶ Press “+”“-” button to enter the first digital

▶ Repress “SET” button, the second digital blinks

▶ Press “+”“-” button to enter the second digital

▶ Repress “SET” button, the third digital blinks

▶ Press “+”“-” button to enter the third digital

▶ Repress “SET” button, the fourth digital blinks

▶ Press “+”“-” button to enter the fourth digital

▶ Press “SET” button, “PWND 0000” displays on the screen, ask for entering a new password, doing like above to enter the new password

▶ Press “SET” button, “PWDG 0000” displays on the screen, ask for reentering the new password, doing like above to reenter the new password,

“PWOK” displays on the screen to indicate reentering password successfully.



▶ Press “ESC” button to exit set program or wait for 20 seconds to exit automatically.

**Note:** The factory default password is “0000”, if no new password is set, then just press “set” button four times to access menu.



**Warning!** If the password is forgot, it is not possible to recover, but you can recover the password to factory set, then you can reedit a new password like above described steps, doing like following to recover to factory set.

▶ Switch-off the power of controller.

▶ Press “SET” button and hold it down, then switch-on the power of controller, wait several seconds, after buzzer makes “du-----” 3 times, then release “SET” button. Controller recovers to factory set (0000) , a new password can be reset now.

### 5.12 RSET Recovery factory setting

#### Setup steps:

To access main menu REST,

▶ Press “SET” button, “YES” displays on the screen.

▶ Hold down “SET” button, buzzer makes “du-----” 3 times, then release “SET” button. Controller recovers to factory set, new paramters can be reset now.

▶ Press “ESC” button to exit set program or wait for 20 seconds to exit automatically.



### 5.13 On/OFF button

When power is given controller, default set is turning on the controller, under the standby status,

▶ Press “On/Off” button for 3 seconds; controller is switched off, “OFF” displays on the screen.

▶ Repress “On/Off” button, controller is switched-on again.

### 5.14 Manual heating

#### Description:



Electrical heater, gas or oil boiler can be as back-up devices in a solar system, this controller can achieve constant temperature controlling, when controller gets temperature signal of top part tank (T3) is 5°C below the preset temperature, back-up heating will be triggered. When temperature of top part tank (T3) reaches to the preset temperature, heating is ceased.

**Conditions for triggering manual heating function:** the setting temperature should be 5°C higher than tank temperature.

**Activate/deactivate the function:**

▶ Press “Heating” button, temperature “H1 55 °C” blinks on the screen.

▶ Press “+”“-” button to adjust switch-on temperature, adjustable range 10 °C~80 °C, factory set is 55 °C.

After 20 seconds, this function is activated,  signal displays on the screen, and heating signal  blinks also.

▶ Press “Heating” button again, to switch-off manual heating function.

**Note:** manual heating can only heat tank one time, after manual heating is triggered, when temperature of tank rises up to the preset temperature, manual heating ceases, and manual heating function will be deactivated automatically, if customer wants to heat again, you need redo according to above steps.

## 5.15 Manual Water Loading

**Description:**

When the storage is lack of water, it is necessary to load water in time, user can press “Water Loading” button to activate this function. If current water level is higher than the preset water level of manual loading function, then even you press that button, the function is still invalid, just when the storage water level is 3cm below the preset manual load water level, this function just can come into true.

**Activate/deactivate the function:**

▶ Press “water loading” button, “W1 60” blinks on the screen.

▶ Press “+”“-” button to adjust switch-on water level, adjustable range 30CM~100CM, factory set is 60CM.

After 20 seconds, this function is activated,  signal displays on the screen,

▶ Press “water loading” button again, to switch-off manual water loading function.

**Note:** manual water loading is one time function. After manual water loading is triggered, when water level rises up to the preset level, manual water loading ceases, and manual water loading function will be deactivated automatically.

## **5.16 Temperature check**

Under standby status,

▶ Press “+”“-” button can check the value of temperature sensors T1 ~ T7, week and clock.

When checking temperature, T1 ~ T7 will displays one by one, corresponding sensor signal

—● blinks, TST is for storage temperature.

## **6. Protection function**

### **6.1. Memory protection**

In case power failure occurs, controller keeps the parameter settings unchanged.

### **6.2 Screen protection**













When no any press on button for 3 minutes, screen protection is activated automatically, and then LED lighting lamp is switched-off. Through press any button to light LED lamp again.

## 7. Trouble shooting

### 7.1 Trouble protection

a. When there is a break or short circuit between the connection of temperature sensors, controller switches off the corresponding functions and no more output signals are given, at the same time error signals  blinks on the display. If controller does not work correctly, please check following points.

► Press “+”“-” button to check error code,  Signal displays on the LCD screen

Error message on LCD screen	Meaning	Cause of error	Error rectification
 1 	T1 sensor problem	Open or short circuit	Check resistance value, replace
 2 	T2 sensor problem	Open or short circuit	Check resistance value, replace
 4 	T4 sensor problem	Open or short circuit	Check resistance value, replace
 5 	T5 sensor problem	Open or short circuit	Check resistance value, replace
 6 	T6 sensor problem	Open or short circuit	Check resistance value, replace
 7 	T7 sensor problem	Open or short circuit	Check resistance value, replace

**Note:** since activated or deactivate functions are different, above mentioned information will be different too.

### 7.2 PT1000/NTC10K resistance value



**Warning!** Remove the device from the mains supply before opening the case.

A potentially defective sensor can be checked using an ohmmeter. To do this, the sensor must be disconnected, its resistance measured, and the value compared with the figures in the table below, small deviation ( $\pm 1\%$ ) is acceptable,

#### PT1000 resistance value

°C	0	10	20	30	40	50	60	70	80	90	100
Ω	1000	1039	1077	1116	1155	1194	1232	1270	1309	1347	1385

**NTC 10K B=3950 resistance value**

°C	0	10	20	30	40	50	60	70	80	90	100
Ω	33620	20174	12535	8037	5301	3588	2486	1759	1270	933	697

**8. Quality Guarantee**

Manufacturer provides following quality responsibilities to end-users: within the period of quality responsibilities, manufacturer will exclude the failure caused by production and material selection. A correct installation will not lead to failure. When a user takes incorrect handling way, incorrect installation, improper or crud handling, wrong connection of sensor in system and incorrect operation, the quality responsibility is invalid for them.

The warrantee expires within 24 months after the date of purchasing the controller.

**9. Technical data**

Dimension	210mm×145mm×48mm
Power supply	AC200~240V 50~60Hz
Power consumption	<4W
Accuracy of temperature measuring	±2°C
Range of collector temperature measuring	-10~220°C
Range of tank or pipe temperature measuring	0~110°C
Inputs T1 :Pt1000 sensor (≤500°C) for collector (silicon cable≤280°C), T2,T3,: NTC10K, B3950 sensor (≤ 135°C) for tank, (PVC cable ≤105°C), T4,T5,T6,T7: NTC10K, B3950 sensor (≤ 135°C) for tank, (PVC cable ≤105°C),(optional)	
Outputs	7 relays, <100W
Ambient temperature	-10~50 °C
Water proof grade	IP40

**10. Delivery scope**

Description	Quantity
Controller	1
Operation manual	1
PT1000 sensor (size: φ6*50mm,cable length1.5m)	1
NTC10K (size: φ6*50mm,cable length 3 m)	2
Thermal well (1/2')	2
Electro polar water level sensor	1
Pressure water level transmitter ( optional)	1
Grundfos pressure sensor ( optional)	1

Appendix1: (SR530F8 type B)



Slave control