

Science and Technology Create Perfection

Installation and Operating Manual

SR1128 SOLAR CONTROLLER

For Split Pressurized Hot Water System



⚠ Read the instruction carefully please before operation!

Content

1. Safety information	3
1.1 Installation and commissioning	3
1.2 About this manual	3
1.3 Liability waiver	3
1.4 Important remark	4
1.5 Description of symbols	4
2. Overview	4
2.1 Introduction of controller	4
2.2 Scope of delivery	5
2.3 Technical data	5
3. Installation	6
3.1 Installing controller	6
3.2 Wire arrangement	6
3.3 Wire connection	7
3.4 Menu structure	8
3.5 Menu description	9
3.6 System description	10
1 collector array- 1tank -1 circuit pump-back-up heater	10
4. Function operation and parameter setup (user grade)	11
4.1 Set time/week	11
4.2 tHET Timing Heating	11
5. Function operation and parameter setup (engineer grade)	15
5.1 Access main menu	15
5.2 DT Temperature difference	15
5.3 TEMP Temperature	16
5.3.1 EMOF Collector maximum switch-off temperature (for collector emergency close function)	17
5.3.2 EMON Collector maximum switch-on temperature (for collector emergency close function)	18
5.3.3 CMX Maximum limited collector temperature (collector cooling function)	18
5.3.4 CMN low temperature protection of collector	19
5.3.5 CFR frost protection of collector	20
5.3.6 REC Storage re-cooling function	20
5.3.7 Maximum temperature of tank 1	21
5.4 PUMP circuit pump speed adjust set	22
5.4.1 DTS Standard temperature difference for circulation pump 1 (speed adjusting) .	22
5.4.2 RIS Gain for circulation pump 1 (speed adjusting)	23

5.5 OHQM Thermal energy measuring	23
5.5.1 FMAX Flow rate.....	24
5.5.2 MEDT Type of heat transfer liquid.....	25
5.5.3 MED% Concentration of heat transfer liquid	25
5.6 INTV Pump interval function	25
5.6.1 ISTAR Turn-on time set for pump interval running function.....	26
5.6.2 IEND Turn-off time set for pump interval running function	26
5.6.3 ISTEP Pump interval time	26
5.6.4 IRUN Pump running time.....	27
5.7 FUN Auxiliary function	27
5.7.1 DVWG Anti legionnaires' function	27
5.8 OSDC SD card data save function.....	28
5.8.1 OSDC Card function switch-on and off.....	28
5.8.2 LOGI Data save intervals.....	28
5. 9 UNIT Display unit °C and °F switches	29
5.10 HND Manual control	29
5.11 REST Recovery to factory set.....	30
5.12 Password set.....	30
6. Button function	31
6.1 Holiday function.....	31
6.2 Manual heating.....	32
6.3 Temperature query function	32
7 Protection function.....	33
7.1. Memory protection.....	33
7.2 Screen protection	33
7.3 pump idling protection	33
8. Trouble shooting.....	34
8.1 Trouble protection.....	34
8.2 Trouble checking	34
9. Quality Guarantee	35
10. Accessories	36

1. Safety information

1.1 Installation and commissioning

- When laying cables, please ensure that no damage occurs to any of the constructional fire safety measures presented in the building.
- The controller must not be installed in rooms where easily inflammable gas mixtures are present or may occur.
- The permissible environmental conditions can't be exceeded at the site of installation.
- Before connecting the device, make sure that the energy supply matches the specifications that controller requires.
- All devices connected to the controller must conform to the technical specifications of the controller.
- All operations on an open regulator are only to be conducted cleared from the power supply. All safety regulations for working on the power supply are valid.
- Connecting and /or all operations that require opening the regulator (e.g. changing the fuse) are only conducted by specialists.

1.2 About this manual

This manual describes the installation, function and operation of a solar thermal controller. When installing the remaining components e.g. the solar collectors, pump assemblies and the storage unit, it should be sure to observe the appropriate installation instructions provided by each manufacturer. Only trained professional personnel may perform installation, electrical connection, commissioning and maintenance of the device. The professional personnel must be familiar with this manual and follow the instructions contained herein.

1.3 Liability waiver

The manufacturer cannot monitor the compliance with these instructions or the circumstances and methods used for installation, operation, utilization and maintenance of this controller. Improper installation can cause damages to material and person. This is the reason why we do not take over responsibility and liability for losses, damages or cost that might arise due to improper installation, operation or wrong utilization and maintenance or that occurs in some connection with the aforementioned. Moreover we do not take over liability for patent infringements or infringements – occurring in connection with the use of this controller- on third parties rights. The manufacturer preserves the right to put changes to product, technical date or installation and operation instructions without prior notice. As soon as it becomes evident that safe operation is no longer possible (e.g. visible damage).

Please immediately take the device out of operation. Note: ensure that the device cannot be accidentally placed into operation.

1.4 Important remark

We have carefully checked the text and pictures of this manual and provided the best of our knowledge and ideas, however inevitable errors may exist. Please note that we cannot guarantee that this manual is given in the integrity of image and text, they are just some examples, and they apply only to our own system. Incorrect, incomplete and erroneous information and the resulting damage we do not take responsibility.

1.5 Description of symbols



Safety instruction:

The safety instructions in the manual are marked with a warning triangle. They indicate measures, which can lead to personal injury and safety risks.

Operation steps: small triangle “▶” is used to indicate operation step.

Notes: Contains important information about operation or function.

2. Overview

2.1 Introduction of controller

- LCD display
- 4 sensor inputs
- 1 relay output
- 1 PWM output for speed control of pump
- Data saved on SD card (Picture 1, 2, 3)
- RS485 remote control(Picture 4)
- Timing and temperature set point control function
- Energy saved on/off operation model

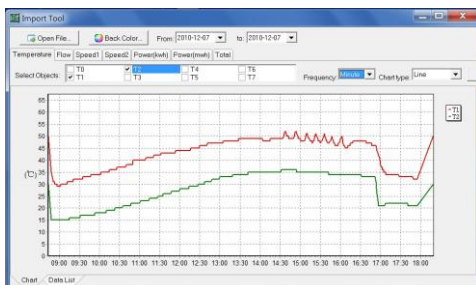

Picture 1

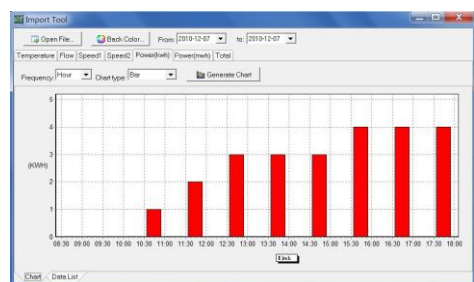

Picture 2

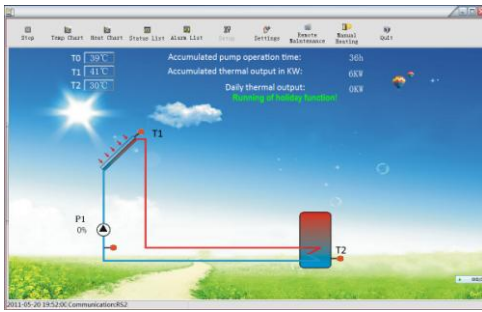

Picture 3

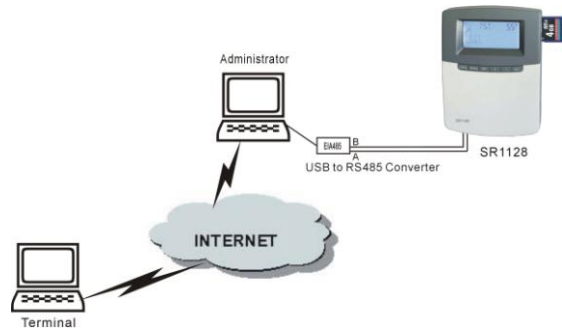

Picture 4

2.2 Scope of delivery

- 1 x controller
- 1 x user manual
- 2 x screw and dowel
- 1 x PT1000 sensor ($\phi 6 \times 50$ mm, length of cable 1.5 meter)
- 2 x NTC10K ($\phi 6 \times 50$ mm, length of cable 3 meter)
- 1 x bag of strain relief

2.3 Technical data

- Material of cases: ABS
- Available ambient temperature: 0 ... 40 °C
- Dimensions: 188 x 138 x 43 mm
- Mounting: on wall or in the electrical cases
- Operation button: 6 operation buttons on panel
- Functions: controller used in solar hot water system and solar heating system, has functions like temperature difference control, thermal energy measuring, accumulated running time of solar circuit pump, collector interval function, thermostat, storage layer heated, priority logic, back-up heating, heat transferring, Anti-Legionella function, PWM pump speed etc.
- Communication port: SD card groove.
- Power supply: 100 ... 240V ~, 50 ... 60 H z
- Power consumption : < 1W
- Accuracy of temperature measuring : $\pm 2^{\circ}\text{C}$
- Range of collector temperature measuring: -10- 200°C
- Range of tank or pipe temperature measuring: 0-110°C
- Inputs: 1 x Pt1000 sensor ($\leq 500^{\circ}\text{C}$) for collector (silicon cable $\leq 280^{\circ}\text{C}$),
3 x NTC10K, B3950 sensor ($\leq 135^{\circ}\text{C}$) for tank, (PVC cable $\leq 105^{\circ}\text{C}$),

1 x RS485 remote control connection

- Outputs: 1 PWM output ($\leq 200W$) ; 1 relay output (each available power $\leq 300W$)
- Ambient temperature: $-10-50^{\circ}C$
- Water proof grade: IP40

Note: SD card isn't included within the delivery scope of controller.

3. Installation

Controller can only be installed indoors, far away from dangerous place and away from the electromagnetic field.

3.1 Installing controller

Note: the controller can only be mounted in an area having an adequate level of protection.

- ▶ Determine the mounting site of controller.
- ▶ Drill the upper fixing hole on the wall.
- ▶ Fasten a screw.
- ▶ Move the terminal cover
- ▶ Hang the base plate on the position ① (showed in picture)
- ▶ Mark the position of 2 bottom holes ②
- ▶ Remove the base plate
- ▶ Drill the bottom fixing hole
- ▶ Re-hang the base plate on screw ①
- ▶ Fasted screw on ② and fix base plate.



3.2 Wire arrangement

Depending on the type of installation, the cables may enter the controller through the rear hole of the case A or the lower side hole of the case B.

Cable comes from the rear hole A: Remove the plastic flaps from the rear side of the case using an appropriate tool.

Cable comes from the below hole B: Cut the left and right plastic flaps using an appropriate tool (e.g. knife) and break them out of the case.

Notes: the flexible wire must be fastened on the case using the clamps C provided.

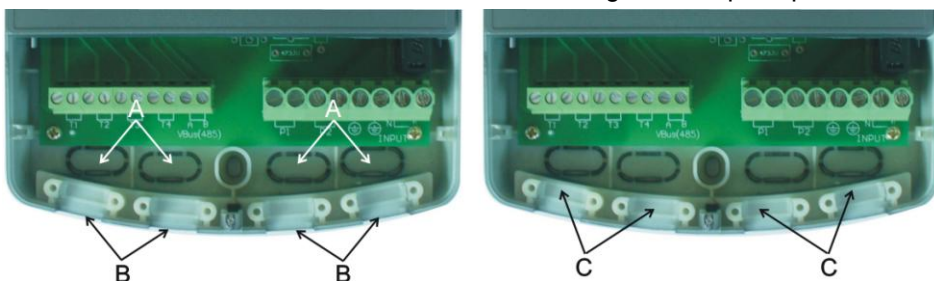

3.3 Wire connection



Before opening the terminal, please be sure to switch-off the power and pay attention to the local electricity supply rules.

Input Ports:

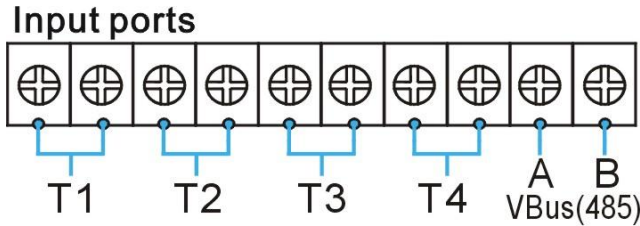

Inputs T1: For PT1000 temperature sensor, used for measuring the temperature of collector and measuring the produced thermal energy.

Inputs T2 ~ T4: for NTC10K, B=3950 temperature sensor, used for measuring the temperature of storage or pipe.

VBus (485): for RS485 remote control connection.

- **Advice regarding the installation of temperature sensors**

- Only original factory enclosed Pt1000 temperature sensors are approved for use with the collector, it is equipped with 1.5meter silicon cable and suitable for all weather conditions, the temperature sensor and cable are temperature resistant up to 280°C, not necessary to distinguish the positive and negative polarity of the sensor connection.
- Only original factory enclosed NTC10K, B=3950 temperature sensors are approved for use with tank and pipe, it is equipped with 1.5meter PVC cable, and they are temperature resistant up to 105°C, not necessary to distinguish the positive and negative polarity of the sensor connection.
- All sensor cables carry low voltage, and to avoid inductive effects, must not be laid close to 230 volt or 400-volt cables (minimum separation of 100mm)
- If external inductive effects are existed, e.g. from heavy current cables, overhead train cables, transformer substations, radio and television devices, amateur radio stations, microwave devices etc, then the cables to the sensors must be adequately shielded.
- Sensor cables may be extended to a maximum length of ca. 100 meter, when cable's length is up to 50m, and then 0.75mm² cable should be used. When cable's length is up to 100m, and then 1.5mm² cable should be used.

- Output ports

Output ports

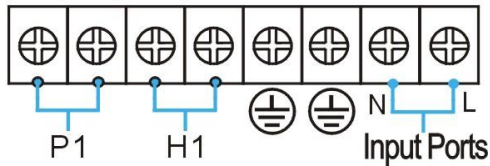

Input Ports: Input ports L, N is power connection terminal, please connect correctly.

⊕ is Ground line terminal.

Output P1: Semiconductor relay (SCR relay), for solar circuit pump, also suitable for RPM (speed) control; Max. Switching current: 1A.

Output H1: for by-pass circuit pump or valve, electromagnetic relay, max. switching current 3.5A, R1 ports are always open

Note: Depending on the solar system selection, pump and sensors should be connected to the controller are different, all wires should be installed in protection pipe.

3.4 Menu structure

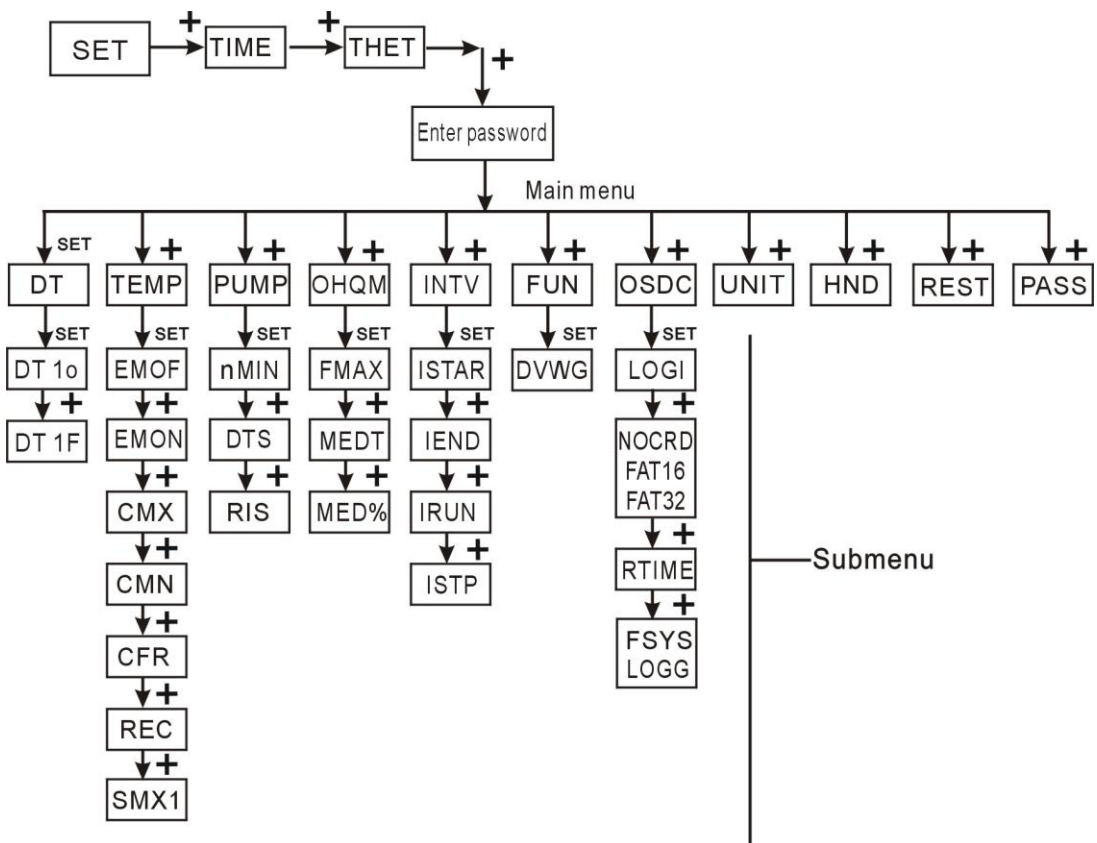

Submenu:

Through submenu, user can set the parameter as desired value, please check it carefully.

3.5 Menu description

Code (Main menu)	Code (Submenu)	Menu Description
DT		For set the operation temperature difference
TEMP		For set correlative temperatures
	EMOF	The maximum switch-off temperature of collector
	EMON	The maximum switch-on temperature of collector
	CMX	The maximum temperature of collector (Collector cooling function)
	CMN	Low temperature protection of collector
	CFR	Frost protection of collector
	REC	Tank recooling function
	SMX1	Maximum temperature of tank1
PUMP		For set the speed parameters of circuit pump
	nMIN	Speed adjust of circuit pump (RPM control)
	DTS	Standard temperature difference of pump (for speed adjust of circuit pump)
	RIS	Increase scale of pump (for speed adjust of circuit pump)
OHQM		For thermal energy measuring
	FMAX	Flow rate
	MEDT	Type of heat transfer liquid
	MED%	Concentration of heat transfer liquid
INTV		For timing function
	ISTAR	Switch-on time of timing function
	IEND	Switch-off time of timing function
	IRUN	Pump interval run-on time
	ISTP	Pump interval run-off time
FUN		Auxiliary functions
	DVWG	Anti legionnaires' function
OSDC		SD card function
	LOGI	Data save interval (in minute)
	NOCRD FAT16 FAT32	No card in groove Memory < 2G Memory > 2G
	RTIME	left time available for saving data (in day)

	FSYS LOGG	Error on system files Possible to log
UNIT		Celsius and Fahrenheit temperature switch
HDN		Manual controlling
REST		Recovery to factory set
PASS		Password set

3.6 System description

Note: storage temperature sensor T3 is optional sensor, if this sensor is not installed on the upper part of the storage, controller will adopt the temperature signal from sensor T2 installed on the bottom part of storage to control back-up heater or circuit pump.

1 collector array- 1tank -1 circuit pump-back-up heater

System description:

Controller compares the temperature between collector T1 and storage T2 (bottom part), if the temperature difference (DT) rises up to the preset switch-on ($\Delta T1$)or is over it, circuit pump P1 is triggered , and then storage is heated until DT drops to the switch-off DT or when the storage temperature T3 rises up to its preset maximum temperature. Then circuit pump P1 is ceased.

Back-up heating: (see details at tHET timing heating menu)

With the preset heating time section, if tank temperature (T3) drops to the switch-on temperature of heating, then back-up heat resource H1 is triggered automatically, when tank temperature T3 rises up to the preset switch-off temperature, then output H1 is ceased.

T1: Temperature sensor on collector

T2: Temperature sensor on the bottom part of tank

T3: Temperature sensor on the top part of tank (optional)

T4: Sensor for thermal energy measuring function, installed on the flow pipe to collector(not included within delivery scope)

P1: Solar circuit pump

H1: Back-up heater

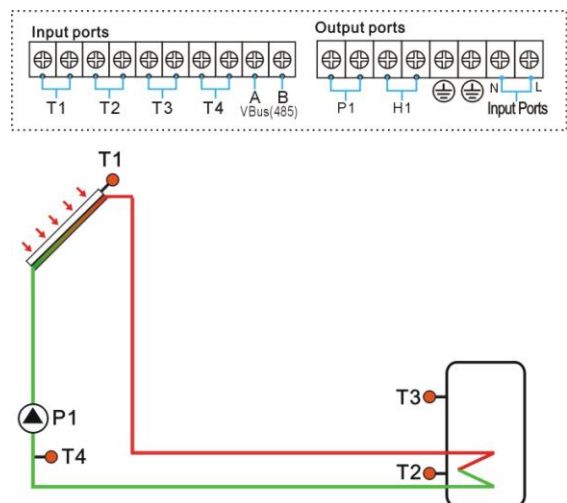

4. Function operation and parameter setup (user grade)

4.1 Set time/week

- ▶ Press “SET” button, “TIME” displays on the screen,
- ▶ Repress “SET” button, hour selection area “00” blinks on the display screen.
- ▶ Press “+” “-” button to set hour of clock
- ▶ Press “SET” button again; minute area “00” blinks
- ▶ Press “+” “-” button to set minute of clock.
- ▶ Press “SET” again, week area “MO” blinks
- ▶ Press “+” “-” button to set week.
- ▶ Press “SET” again, “DAY/MONTH/YEAR” area “Year” blinks
- ▶ Press “+” “-” button to set year.
- ▶ Press “SET” again, “Month” blinks
- ▶ Press “+” “-” button to set month.
- ▶ Press “SET” again, “DAY” blinks
- ▶ Press “+” “-” button to set day.
- ▶ Press “ESC” button to exit set program, or wait for 20 seconds to exit program automatically. The set parameter values of time and week are saved automatically,

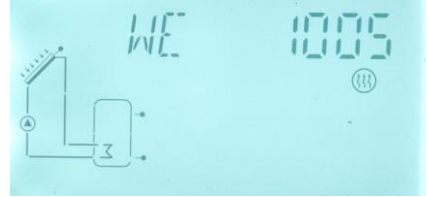

Code	Meaning
MO	Monday
TU	Tuesday
WE	Wednesday
TH	Thursday
FR	Friday
SA	Saturday
SU	Sunday

4.2 tHET Timing Heating

Description:

Electrical heater, gas boiler or oil boiler can be integrated into solar system used as back-up of system, and they can be triggered automatically at preset schedule by preset temperature. Within a preset schedule, when the temperature (T3) of top part of tank drops below the preset switching-on temperature of this function, back-up heating H1 starts to work, when T3 rises up to the preset turning off temperature, back-up heating is stopped. Within 24 hours, three time sections can be set with this controller.

Factory set:

The first schedule: back-up heating function starts at 4:00 and ends at 5:00 am. Within this time section, default switch-on temperature is 40°C; default switch-off temperature is 45°C.

The second schedule: starts at 10:00 and ends also at 10:00 am, it means no back-up heating in this time.

The third schedule: back-up heating function starts at 17:00 and ends at 22:00 pm. Within this time section, default switch-on temperature is 50°C; default switch-off temperature is

55°C.

The switch-on temperature adjustable range: 10 °C ~ (OFF-2 °C)

The switch-off temperature adjustable range: (ON+2 °C) ~ 80 °C

If you want to shut off one timing heating, then you can set the turning on time and turning off time with a same value (for example, the second time section no this function, then you can set turning on/off time is 10:00 ~ 10:00)

When time is outside of the preset schedule, back-up heating doesn't work automatically even when the tank temperature drops to the switch –on temperature of heating.

Note:

- When there is no sensor installed in the top part of tank (no T3 sensor), controller will take the signal of T2 (sensor in bottom of tank) automatically to control this function.
- The time in this controller is 24 hours model, when you set schedule, the switch-off time of heating should be larger than switch-on time. For example: if you set the switch-on time of heating is at 17:00, but switch-off time of heating is 6:00, then this setting doesn't take effect, that means within this time section, heating function doesn't work. The correct set is like flowing: it should be divided into two time sections, one time section is from 17:00 to 23:59, the other time section is from 00:00 to 06:00.

Setup steps: under standby,

▶ Press “SET” button, “tHET” displays on the screen.

▶ Repress “SET” button to access “tHET” program menu.

▶ Repress “SET” button again, to set parameters of “tHET”, “tH 1o 04:00” displays on the screen, “04” of hour time blinks on screen, the switch-on time and temperature for the first schedule of heating function can be set.

▶ Press “+” “-” button to adjust hour of time.

▶ Repress “SET” button again, “00” of minute time blinks on screen.

▶ Press “+” “-” button to adjust minute of time.

▶ Repress “SET” button, temperature “40°C” blinks on screen.

▶ Press “+” “-” button, to set the switch-on temperature of heating.

▶ Then, press “ESC” to exit this submenu.

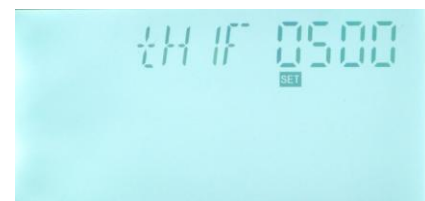

▶ Press “+” button, “tH 1F 05:00” displays on the screen, to access the submenu of the switch-off time and temperature for the first schedule of heating function.

▶ Press “SET” button again, “05” of hour time blinks on screen.

▶ Press “+” “-” button to adjust hour of time.

▶ Repress “SET” button again, “00” of minute time blinks on screen.

▶ Press “+” “-” button to adjust minute of time.

▶ Repress “SET” button, temperature “45°C” blinks on screen.

▶ Press “+” “-” button, to set the switch-off temperature of heating.

▶ Then, press “ESC” to exit this submenu, or wait for 20 seconds to exit automatically, the parameter valves are saved automatically.

▶ Press “+” button, “tH 2o 10:00” displays on the screen, to access the submenu of the switch-on time and temperature for the second schedule of heating function.

▶ Press “SET” button again, “10” of hour time blinks on screen.



▶ Press “+” “-” button to adjust hour of time.

▶ Repress “SET” button again, “00” of minute time blinks on screen.

▶ Press “+” “-” button to adjust minute of time.

▶ Repress “SET” button, temperature “50°C” blinks on screen.

▶ Press “+” “-” button, to set the switch-on temperature of heating.

▶ Then, press “ESC” to exit this submenu.

▶ Press “+” button, “tH 2F 10:00” displays on the screen, to access the submenu of the switch-off time and temperature for the second schedule of heating function.

▶ Press “SET” button again, “10” of hour time blinks on screen.



▶ Press “+” “-” button to adjust hour of time.

▶ Repress “SET” button again, “00” of minute time blinks on screen.

▶ Press “+” “-” button to adjust minute of time.

▶ Repress “SET” button, temperature “55°C” blinks on screen.

▶ Press “+” “-” button, to set the switch-off temperature of heating.

▶ Then, press “ESC” to exit this submenu, or wait for 20 seconds to exit automatically, the parameter valves are saved automatically.

▶ Press “+” button, “tH 3o 17:00” displays on the screen, to access the submenu of the switch-on time and temperature for the third schedule of heating function.

▶ Press “SET” button again, “17” of hour time blinks on screen.



▶ Press “+” “-” button to adjust hour of time.

▶ Repress “SET” button again, “00” of minute time blinks on screen.

▶ Press “+” “-” button to adjust minute of time.

▶ Repress “SET” button, temperature “50°C” blinks on screen.

▶ Press “+” “-” button, to set the switch-on temperature of heating.

▶ Then, press “ESC” to exit this submenu.

▶ Press “+” button, “tH 3F 22:00” displays on the screen, to access the submenu of the switch-off time and temperature for the third schedule of heating function.



▶ Press “SET” button again, “22” of hour time blinks on screen.

▶ Press “+” “-” button to adjust hour of time.

▶ Repress “SET” button again, “00” of minute time blinks on screen.

▶ Press “+” “-” button to adjust minute of time.

▶ Repress “SET” button, temperature “55°C” blinks on screen.

▶ Press “+” “-” button, to set the switch-off temperature of heating.

▶ Then, press “ESC” to exit this submenu, or wait for 20 seconds to exit automatically, the parameter valves are saved automatically.

Note: when no gas or oil boiler is connected to solar system, electrical heater can be installed as back-up device, when electrical heater is in operation status, signal (⚡) blinks on screen, and LED light is on.

Application sample:

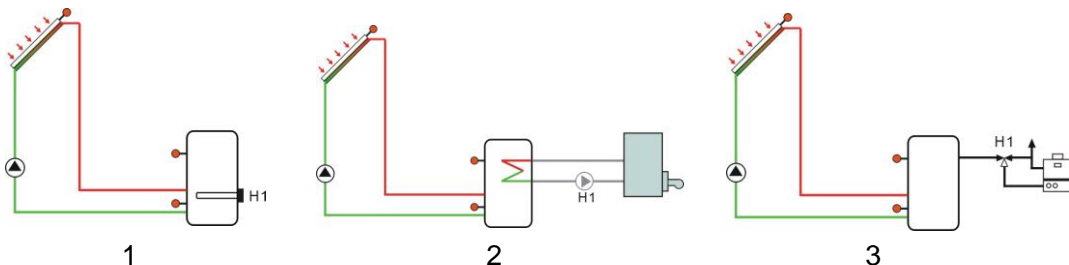

If customer uses electrical heater as back-up, please according to the power of electrical heater to equip corresponding safety devices like contactor and breaker with this controller, we strongly recommend equipping with SR802 device with this controller, (SR802 detailed technical data see paragraph spare parts)

5. Function operation and parameter setup (engineer grade)

5.1 Access main menu

Under standby, doing like following to access main menu.

▶ Press “SET” button, then press “+” button 3 times and wait for “PWD 0000” appears on the screen, then repress “SET” button, the left first digital blinks, ask for entering password, factory default set password is “0000”



- ▶ Press “+” “-” button to enter first digital of password.
- ▶ Repress “SET” button, the second digital blinks
- ▶ Repress “+” “-” button, to enter second digital of password.
- ▶ Repeat press “SET” button, the third digital blinks
- ▶ Repress “+” “-” button, to enter third digital of password.
- ▶ Repeat press “SET” button, the forth digital blinks
- ▶ Repress “+” “-” button, to enter forth digital of password.
- ▶ Repress “SET” button, to access the main menu.
- ▶ Press “+” “-” button, select any menu you wanted.
- ▶ Press “ESC” button, you can exit main menu.

Note: default factory set password is “0000”, if you don’t set new password, just press “SET” four times, then you can access main menu interface

5.2 DT Temperature difference

Description:

Solar circuit pump P1 is triggered by the temperature difference function, so long as the temperature difference between collector and storage reaches the switch-on DT, solar circuit pump is triggered.

For example: the switch-on DT is 8°C, switch-off DT is 4°C, if the temperature on the bottom part of storage is 20°C, then just when collector temperature rises up to 28°C, pump is triggered, and when collector temperature drops to 24°C, pump is ceased.

Note: the switch-on/off DT of 8°C and 4°C are standard system setting according to many

years' experience, only in special application cases it needs to be changed, (e.g. far distance heat transferring), normally we recommend using default set. Switch-on and switch-off DT are alternating set. To avoid mistake the minimum difference between two temperature differences ($\Delta T_{on} - \Delta T_{off}$) is set as 2 °C.

Setup temperature difference:

Under standby, following steps descript in paragraph 6.1 to access main menu DT

▶ Press “SET” button, to access settings program of main menu DT, “DT 1o 08 °C” displays on screen, “08 °C” blinks, the first switch-on temperature difference can be set.



▶ Press “+” “-” button, to adjust the value of switch-on DT, adjustable range ($OFF+2\text{ °C}$) $\sim 20\text{ °C}$, factory setting is 8 °C

▶ Press “ESC” button to exit this setting, parameter is saved automatically.

▶ Press “+” button, “DT 1F 04 °C” displays on screen, the first switch-off temperature difference can be set.



▶ Press “SET” button, “04 °C” blinks.

▶ Press “+” “-” button to adjust the value of switch-off DT, adjustable range $0\text{ °C} \sim (ON-2\text{ °C})$, factory set is 4 °C.

▶ Press “ESC” to exit menu, or wait for 20 seconds to exit automatically, the setup parameters are saved automatically.

5.3 TEMP Temperature

For solar system, the factory set parameters are for the best operation condition, which is fully integrated into the entire solar system. But these parameters can also be set individually to cater the special requirements, please carefully observe the operation data of system components after setting.

Note: Parameters that can be set rely on the system design, not all the parameters can be Following submenu can be access though TEMP main menu.

Tem. Code	Function of temperature	Adjustable range	Factory set	Function exit tem.	Paragraph
EMOF	Collector maximum switch-off temperature	(ON+3 °C)~ 200 °C	130 °C		5.3.1
EMON	Collector maximum switch-on temperature	80 °C ~ (OF-3 °C)	120 °C		5.3.2
CMX	Maximum limited collector temperature (collector cooling function)	70 °C ~190 °C	110 °C	107 °C	5.3.3
CMN	Low temperature protection of collector	0 °C~90 °C	---		5.3.4
CFR	Frost protection of collector	-10 °C~10 °C	---		5.3.5
REC	Tank re-cooling function		OFF		5.3.6
SMX1	Maximum temperature of tank 1	2 °C~95 °C	60 °C	58 °C	5.3.7

5.3.1 EMOF Collector maximum switch-off temperature (for collector emergency close function)

Function description:

When collector temperature rises up to this maximum switch-off limited temperature (EM), collector emergency function is activated, solar circulation pump is stopped in order to avoid the damage of system's other components caused by high temperature. The adjustable range of EMOF temperature is (ON+3 °C)~200 °C, factory set is 130 °C. If the temperature of collector rises up to EMOF limited temperature, solar circuit pump is ceased, but when collector temperature drops to the collector maximum switch-on temperature EMON (factory set is 120 °C) , solar circuit pump will be reset, and collector emergency close function is deactivated.

Setup steps:

To access main menu TEMP, then select submenu EMOF, "EMOF 130 °C" displays on the screen



▶ Press "SET" button, parameter "130 °C" blinks.

▶ Press "+" "-" button, to adjust this maximum switch-off temperature, adjust range (ON+3 °C) ~200 °C, factory set is 130 °C

▶ Repress "SET" button to activate and deactivate this function, if deactivate the function, "EMOF - - -" displays on the screen.

▶ Press "ESC" button to exit menu or wait for 20 seconds to exit automatically, set parameters are saved automatically.

5.3.2 EMON Collector maximum switch-on temperature (for collector emergency close function)

Setup steps:

To access main menu TEMP, then select submenu EMON, "EMO 120°C" displays on screen

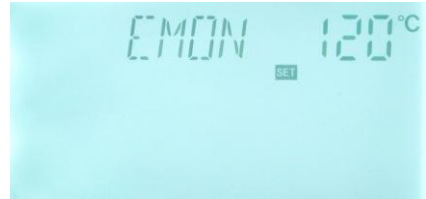

▶ Press "SET" button, parameter "120 °C" blinks.

▶ Press "+" "-" button, to adjust this maximum switch-on temperature, adjust range 80 °C ~ (OF-3 °C), factory set is 120 °C

▶ Repress "SET" button to activate and deactivate this function, if deactivate the function, "EMON - - -" displays on screen.

▶ Press "ESC" button to exit menu or wait for 20 seconds to exit automatically, set parameters are saved automatically.



When these two signals of EM blink on the screen, it indicates collector emergency close function is activated, and at this moment temperature of tanks reaches to its maximum limited temperature



When only this signal of EM blinks on the screen, it indicates collector emergency close function is also activated, but temperature of tank doesn't reach to its maximum limited temperature

5.3.3 CMX Maximum limited collector temperature (collector cooling function)

Function description:

If hot water in tank isn't used for long time, then the capacity that solar system absorbs solar irradiation reduces, when tank temperature rises to its preset maximal temperature, solar circuit pump is ceased compulsively even the temperature difference is satisfied. then when more solar irradiation shines in, as a result collector temperature will rise continuously, temperature of collector maybe rise up to the evaporated temperature of heat fluid, this phenomenon names collector - overheat, it should be avoided. Through set the Maximum limited collector temperature (collector cooling function) it can delay the vaporization of the heat transfer fluid. Shortly before reaching the maximum temperature of the collector, the solar pump starts working to cool down the heat transfer fluid using the heat losses occurring in pipelines and storage cylinder.

When collector temperature rises up to its maximal temperature, solar pump will be triggered again even at the case that tank temperature is already to its maximal temperature. And solar pump works until the temperature of collector drops because of this reversed

circulation or when tank temperature rises its emergency temperature (95°C).

When ☀ displays, and ⚠ blinks on the screen, it indicates that tank emergency temperature reaches, tank temperature is $\geq 95^{\circ}\text{C}$

Setup steps:

To access main menu TEMP, then select submenu CMX, “CMX 110 °C” displays on screen

▶ Press “SET” button, “110 °C” blinks.

▶ Press “+” “-” button to adjust collector limited maximum temperature , adjust range : (70 °C~190 °C),

Factory set is 110 °C

▶ Press “SET” button to activate and deactivate this function, if deactivate the function, “CMX - - -” displays on screen.

▶ Press “ESC” button to exit menu or wait for 20 seconds to exit automatically, set parameters are saved automatically.



☀ CMX signal displays on screen, it indicates that collector cooling function is activated.

5.3.4 CMN low temperature protection of collector

Description:

When the actual temperature of collector is below the preset CMN temperature, solar circuit pump is ceased, even when the temperature difference between collector and storage exceeds switch-on temperature difference, solar pump doesn't work yet. When the temperature of collector is 3°C higher than the preset CMN temperature, solar circuit pump is standby to work, controller exits this program.

Setup steps:

To access main menu TEMP, then select submenu CMX, “CMN - - -” displays on screen, default set is OFF.

▶ Press “SET” button, default off signal “- - -” blinks on screen.

▶ Repress “SET” button to activate and deactivate this function.

▶ Press “+” “-” button to adjust the low protection temperature of collector CMN, adjustable range (00 °C ~90 °C), after activate the function, factory set is 10 °C

▶ Press “ESC” button to exit the menu or wait for 20 seconds to exit automatically, parameters are saved automatically.





CMN signal displays on screen, it indicates that this function is activated.

5.3.5 CFR frost protection of collector

Description:

In winter when the temperature of collector is below the preset frost protection temperature (factory set is 4 °C), solar circuit pump is triggered to transfer hot water from tank to collector and to heat collector by this reversed circuit. And when tank temperature (T2) drops to 6°C, electrical heater is triggered automatically and it keeps running until tank temperature T2 raises up to 21 °C or it is stopped when program of CFR is exited. When collector temperature rises up to 7 °C, solar circuit pump is ceased, program of CFR exits automatically.

This function is used in system, which uses water as heat transfer liquid, to avoid the freezing of solar heat transfer fluid.

Setup steps:

To access main menu TEMP, then select submenu CFR, “CFR ----” displays on screen, default set is off.

▶ Press “SET” button, default off “- - -” blinks.

▶ Repress “SET” button to activate or deactivate this function

▶ Press “+” “-” button to adjust the temperature of frost protection function, adjustable range is (-10 °C~10 °C) , after function activated, default set is 4 °C

▶ Press “ESC” button to exit the menu or wait for 20 seconds to exit automatically, parameters are saved automatically.



CFR signal displays on screen, it indicates that this function is activated.

Note: this function is only available in special solar system which using no-anti-freezing liquid; this kind of system is only suitable in area where the ambient temperature is near to 0°C only for a few days. If safety requirement is very high, then anti-freezing is necessary, we suggest using suitable anti-freezing liquid to avoid frost problem.

5.3.6 REC Storage re-cooling function

Description:

If storage temperature rises up to its maximum temperature, and at the same time, collector temperature is 5°C lower than storage temperature, then solar pump can be triggered,

through this reversed circulation, storage temperature is reduced by heat loss occurs in collector, solar pump keeps in working until storage temperature drops below its maximum temperature.

Setup steps:

To access main menu TEMP, then select submenu REC, "REC OFF" displays on screen, default set is off.

▶ Press "SET" button, parameter "OFF" blinks on screen

▶ Repress "SET" button to activate or deactivate this function; after function activated, factory set is "REC ON"

▶ Press "ESC" button to exit the menu or wait for 20 seconds to exit automatically, parameters are saved automatically.

☀ REC signal displays on screen, it indicates that this function is activated.



5.3.7 Maximum temperature of tank 1

Description:

When the DT between collector T1 and tank 1 caters the switch-on DT of circulation, solar pump is triggered, but in order to avoid the high temperature inside tank, controller will check whether the temperature (T3) of the top part of tank is higher than the maximum temperature of tank, when T3 is higher than the preset maximum tank temperature SMX, solar pump is ceased even at the case that DT caters condition. When tank temperature drops and is 2°C below the SMX temperature, solar pump restarts when DT caters condition.

Setup steps:

To access main menu TEMP, then select submenu SMX1, "SMX1 60 °C" displays on screen.

▶ Press "SET" button, parameter "60 °C" blinks

▶ Press "+" "-" button to adjust the value of maximum temperature of tank1, adjustable range is (2 °C~95 °C), default set is 60 °C

▶ Repress "SET" button to activate and deactivate this function, if function deactivated, "SMX1 - - -" displays on the screen.

▶ Press "ESC" button to exit the menu or wait for 20 seconds to exit automatically, parameters are saved automatically.

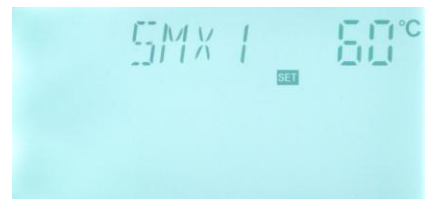



SMX signal displays on screen, it indicates that this function is in activated.

5.4 PUMP circuit pump speed adjust set

Description:

P1 output can be configured to function either as RPM controlled output or simple switch output.

When nMIN is set as 30-90%, P1 output used as RPM output.

When nMIN is set as 100%, it means P1 output used as switch output.

Normal switch output: circuit pump speed control (RPM) is deactivated, pump is operated with a fixed speed, and flow rate is not changed.

RPM control output: (speed control is activated), the control system attempts to maintain a constant temperature difference between collector and tank.

The pump performance is continuously adjusted, based on the temperature difference flow rate of pump is increased or reduced.



Setup steps:

To access main menu PUMP, "PUMP" displays on the screen, press "SET" to access the menu, then "nMIN 100" displays on screen.

▶ Press "SET" button, parameter "100" blinks on the screen.

▶ Press "+" "-" button, to adjust pump speed.

adjustable range: (30~100%) , factory set is 100%.

▶ Press "ESC" button to exit the menu or wait for 20 seconds to exit automatically, parameters are saved automatically.



5.4.1 DTS Standard temperature difference for circulation pump 1 (speed adjusting)

Description:

The preset default minimum pump speed in this controller is 30%. When the switch-on temperature difference (ΔT_{ON}) reaches, solar pump is triggered, and then within 10 seconds, pump speed increases to its minimum speed (30%). Thereafter, controller checks temperature continuously, when a standard temperature difference (DTS) reaches, the speed of pump increases one grade (10%), temperature difference RIS increases every 1°C, speed of pump increases 10% until it reaches to its maximum speed 100%. Through setting the temperature difference increase rate (RIS) can achieve the controlling of pump speed. If temperature difference drops to the switch-off temperature difference (ΔT_{OFF}), circuit pump is ceased.

Setup steps:

To access PUMP, then select submenu DTS “DTS 08 °C” displays on screen.

▶ Press “SET” button, parameter “08°C” blinks on the screen

▶ Press “+” “-” button, to adjust the standard DTS, adjustable range (2 °C~30 °C) , factory set is 08°C

▶ Press “ESC” button to exit the menu or wait for 20 seconds to exit automatically, parameters are saved automatically.



5.4.2 RIS Gain for circulation pump 1 (speed adjusting)

Setup steps:

To access menu PUMP, then select submenu RIS, “RIS 01 °C” displays on screen.

▶ Press “SET” button, parameter “01°C” blinks on the screen

▶ Press “+” “-” button, to adjust standard RIS, adjustable range (1 °C~20 °C) , factory set is 1°C

▶ Press “ESC” button to exit the menu or wait for 20 seconds to exit automatically, parameters are saved automatically.

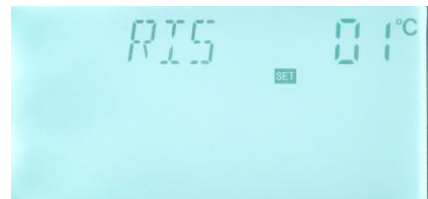

5.5 OHQM Thermal energy measuring

Description:

Controller has function for measuring the thermal energy; it can measure the energy which is transferred from collector to tank. For the sake of measuring, the temperature on flow and return pipe should be checked, and an extra flow meter should be installed on the circulation pipe, it is used for measuring the flow rate.

The thermal energy transferred by solar system is calculated with measured parameters flow rate and temperature T0 (installed on the return pipe). Thermal energy got in the current day displays in DkWh, accumulative thermal energy displays in kWh or MWh. The amount of 2 values is the total energy output.

Note: when T0 input is used, (for example, used in east/west collector), OHQM thermal energy measuring function will be deactivated. Factory set of OHQM is off.

Setup steps:

To select menu OHQM, “OHQM” displays on the screen,

▶ Press “SET” button, parameter “OHQM OFF” appears on the screen

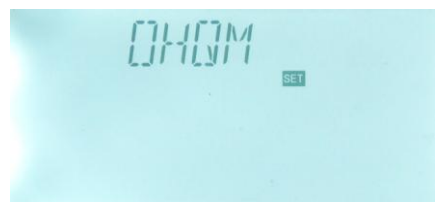

▶ Press “SET” button, parameter “OFF” blinks on the screen

▶ Re-press “SET” button to activate this function, then “OHQM ON” appears on the screen

▶ Press “ESC” button to exit the menu or wait for 20 seconds to exit automatically, parameters are saved automatically.

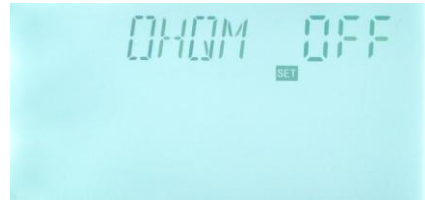

Thermal energy got in current day, accumulative thermal energy and operation time of pump can be reset, doing like following.

Operation steps: under standby status,

▶ Press “+” “-” button, select the thermal energy of current day, “DKWH XX” “SET” displays on the screen.

▶ Press “SET” button for 3 seconds, buzzer makes 3 times “du-----”, the daily thermal energy is cleared, and daily thermal energy is reset to “00”.

▶ Press “+” “-” button, select to check accumulative thermal energy, “KWH XX” or “MWH XX” “SET” displays on the screen.

▶ Press “SET” button for 3 seconds, buzzer makes 3 times “du-----”, the sum thermal energy is cleared, and accumulative thermal energy is reset to “00”.

▶ Press “+” “-” button, select the operation time of pump, “hP XX” “SET” displays on the screen.

▶ Press “SET” button for 3 seconds, buzzer makes 3 times “du-----”, the operation time of pump is cleared, and it is reset to “00”.

Note: Only when the thermal energy measuring function is activated, operation time of circulation pump function just can be triggered.

5.5.1 FMAX Flow rate

FAMX: Flow rate L/min. adjustable range: (0.1~20) L/min, increase rate 0.1L per button press, factory set is 2.0L/min

Setup steps:

To select submenu FMAX, “FMAX 2.0” displays on the screen.

▶ Press “SET” button, parameter “2.0” blinks on the screen

▶ Press “+” “-” button to adjust parameter of flow rate. adjustable range (0.1~20)

▶ Press “ESC” button to exit the menu or wait for 20 seconds to exit automatically, parameters are saved automatically.



5.5.2 MEDT Type of heat transfer liquid

MEDT: type of heat transfer liquid, adjustable range (00~03), factory set : 01

Type of heat transfer liquid:

- 00: Water
- 01: Propylene glycol
- 02: Glycol
- 03: Tyfocor LS/G-LS



Setup steps:

To select submenu MEDT, "MEDT 01" displays on screen.

- ▶ Press "SET" button, parameter "01" blinks on the screen
- ▶ Press "+" "-" button, to adjust type of heat transfer liquid, adjustable range (00~03)
- ▶ Press "ESC" button to exit the menu or wait for 20 seconds to exit automatically, parameters are saved automatically.

5.5.3 MED% Concentration of heat transfer liquid

MED% Concentration of heat transfer liquid (volume percentage %), depending on the type of heat transfer liquid, adjustable range (20 ~70), factory set 40

Setup steps:

To select submenu MED%, "MED% 40" displays on screen.

- ▶ Press "SET" button, parameter "40" blinks on the screen
- ▶ Press "+" "-" button to adjust concentration, adjustable range (20~70)



- ▶ Press "ESC" button to exit the menu or wait for 20 seconds to exit automatically, parameters are saved automatically.

Note: When MEDT is set as 00 or 03, then its MED% concentration doesn't appear.

5.6 INTV Pump interval function

Description:

This function is useful when collector sensor isn't installed on collector (sensor installed on the outlet pipe of collector). In order to measure the actual temperature of collector, when circuit pump is in standby, every 30 minutes (this parameter is set at ISTEP menu), solar pump is triggered to run for 15 seconds (this is set at the IRUN menu), so that the hot water inside the collector can flow into the pipe, where sensor is mounted, as the result, the actual temperature of collector is measured. It is unnecessary to activate this function in all time, you can use it within a preset time section, default set time is 07:00 ~18:00; this time can set

at ISTAR and IEND submenu.

Setup steps:

To select submenu INTV, "INTV" displays on the screen.

- ▶ Press "SET" button to access menu, "INTV OFF" displays.
- ▶ Reprress "SET" button, parameter "OFF" blinks, factory set is "OFF"
- ▶ Press "SET" button, to activate this function, then "INTV ON" displays on the screen.
- ▶ Press "ESC" button to exit the menu or wait for 20 seconds to exit automatically, parameters are saved automatically.



5.6.1 ISTAR Turn-on time set for pump interval running function

Setup steps:

To select submenu ISTAR, "ISTAR 07:00" displays on the screen.

- ▶ Press "SET" button, parameter "07:00" blinks,
- ▶ Press "+" "-" button, to adjust turn-on time.
- ▶ Press "ESC" button to exit the menu or wait for 20 seconds to exit automatically, parameters are saved automatically.



5.6.2 IEND Turn-off time set for pump interval running function

Setup steps:

To select submenu IEND, "IEND 18:00" displays on the screen.

- ▶ Press "SET" button, parameter "18:00" blinks,
- ▶ Press "+" "-" button, to adjust turn-off time.
- ▶ Press "ESC" button to exit the menu or wait for 20 seconds to exit automatically, parameters are saved automatically.



5.6.3 ISTEP Pump interval time

Setup steps:

To select submenu ISTEP, "ISTP 30" displays on the screen.

- ▶ Press "SET" button, parameter "30" blinks; factory

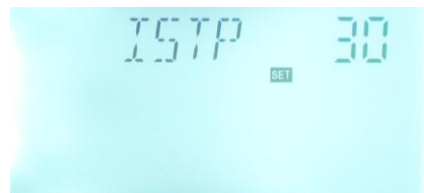

set is “30 minute”

- ▶ Press “+” “-” button, to adjust time, adjustable range (2~ 60 minutes).
- ▶ Press “ESC” button to exit the menu or wait for 20 seconds to exit automatically, parameters are saved automatically.

5.6.4 IRUN Pump running time

Setup steps:

To select submenu IRUN, “IRUN 15” displays on the screen.

- ▶ Press “SET” button, parameter “15” displays and blinks, factory set is “15 seconds”
- ▶ Press “+” “-” button, to adjust time, adjustable range (5~ 120 seconds).
- ▶ Press “ESC” button to exit the menu or wait for 20 seconds to exit automatically, parameters are saved automatically.



5.7 FUN Auxiliary function

The auxiliary functions of this controller can be set under “FUN” menu; it is possible to activate several auxiliary functions at the same time.

5.7.1 DVWG Anti legionnaires' function

Description:

In order to avoid occurring bacteria in water tank when the temperature of tank is lower for a long time, controller will check the temperature of tank every 7 days in a period automatically, if the temperature of tank is never over 70°C during this period, then at the factory default time of 01:00 on Sunday of the period auxiliary heating system is triggered automatically to heat water until it rises up to 70°C (this is factory default set, impossible to reset) , bacteria is killed by high temperature, thereafter function is deactivated.

Setup steps:

To select submenu DVWG, “DVWG ----” displays on screen. Default set is “----”.

- ▶ Press “SET” button, parameter “----” blinks on the screen.
- ▶ Re-press “SET” button, function is triggered. And then “70°C” blinks on the screen.
- ▶ Press “+” “-” button to adjust this temperature, adjustable range is: (5~95°C) .



▶ Press “ESC” button to exit the menu or wait for 20 seconds to exit automatically, parameters are saved automatically.

5.8 OSDC SD card data save function

Description:

Put the SD card in the groove, data is logged immediately. Then under menu of the OSDC card, “OSDC ON” displays automatically, it means data is logging, the interval of data log can be set. If card is full, then data logging is stopped, and CFULL displays on the screen.

5.8.1 OSDC Card function switch-on and off

Setup steps:

To select menu OSDC “OSDC” displays on the screen.

▶ Press “SET” button, “OSDC OFF” appears, in this case, data isn’t saved.

▶ Repress “SET” button, “OFF” blinks on the screen, factory default set: “OFF”.

▶ Repress “SET” button again to activate this function, and “OSDC ON” displays on the screen, start to save data now.

▶ Press “SET” button to exit the menu or wait for 20 seconds to exit automatically, parameters are saved automatically.



5.8.2 LOGI Data save intervals

Description:

By this function, SD card can save data in every 60 seconds (factory default time 60 seconds).

Setup steps:

To select menu LOGI “LOGI 60” displays on the screen.

▶ Press “SET” button to access program, “LOGI 60” appears and “60” blinks.

▶ Press “+” “-” button to adjust data save interval, adjustable range: 01~1200 seconds.

▶ Press “ESC” button to exit the menu or wait for 20 seconds to exit automatically, parameters are saved automatically.



Note: if SD card is used,  card signal will appears on the screen, if SD card is full,

then data log is stopped, and  card signal blinks.

Short message Code	Description
FSYS	File system error
NOCRD	NO card
FAT16	Memory of card is less than 2G
FAT32	Memory of card is larger than 2G
RTIME	Left log time (in days)
LOGI	Data save interval(in minutes)
LOGG	LOG is possible
WRITR	Card written protection

5.9 UNIT Display unit °C and °F switches

Setup steps:

To select menu UNIT, "UNIT" displays on the screen.

- ▶ Press "SET" button to access program, "UNIT °C" appears and "°C" blinks.
- ▶ Press "+" "-" button to switch unit between °C and °F, factory set is °C.
- ▶ Press "ESC" button to exit the menu or wait for 20 seconds to exit automatically, parameters are saved automatically.



5.10 HND Manual control

When using this controller first time or when debugging this controller, output of this controller(P1, H1) can be triggered manually with "On, OFF" control.

Setup steps:

To access main menu HND,

- ▶ Press "SET" button, "HND1 off" displays on the screen, P1 output manually set
- ▶ Repress "SET" button, "HND1 on" displays on the screen, P1 output is switched-on
- ▶ Repress "SET" again, "HND1 off" displays, P1 output is switched-off
- ▶ Press "ESC" to exit P1 setup.



- ▶ Press "+" button, "HND2 off" displays on the screen, P2 output manually set
- ▶ Press "SET" button, "HND2 on" displays on the



screen, H1 output is switched-on

▶Repress “SET” again, “HND2 off” displays, H1 output is switched-off

▶Press “ESC” to exit H1 setup.

Note: when manual mode is activated,  signal displays on the screen, after 15 minutes all outputs are switched-off, controller exits manual mode automatically.

5.11 REST Recovery to factory set

Setup steps:

To access main menu REST,

▶Press “SET” button, “YES” displays on the screen.

▶Hold down “SET” button, buzzer makes “du-----” 3 times, then release “SET” button and wait for display recovery to initial interface, that means controller recovers to factory set, new paramters can be reset now.

▶Press “ESC” button to exit set program or wait for 20 seconds to exit automatically.



5.12 Password set

Setup steps:

To access main menu PASS,

▶Press “SET” button, “PWDC 0000” appears, the left digital blinks, ask for entering current password, factory set is “0000”

▶Press “+” “-” button to enter the first digital

▶Repress “SET” button, the second digital blinks

▶Press “+” “-” button to enter the second digital

▶Repress “SET” button, the third digital blinks

▶Press “+” “-” button to enter the third digital

▶Repress “SET” button, the fourth digital blinks

▶Press “+” “-” button to enter the fourth digital

▶Press “SET” button, “PWDN 0000” displays on the screen, ask for entering a new password, doing like above to enter the new password

▶Press “SET” button, “PWDG 0000” displays on the screen, ask for reentering the new password, doing like above to reenter the new password, “PWOK”



displays on the screen to indicate reentering password successfully.

▶ Press “ESC” button to exit set program or wait for 20 seconds to exit automatically.



Warning If the password is forgot, it is not possible to recover, but you can recover the password to factory set, then you can reedit a password like above descript steps, doing like following to recover to factory set.

▶ Switch-off the power of controller firstly,

▶ Press “SET” and hold it down, then reconnect the power supply.

▶ Buzzer makes “du-----” 3 times, then release “SET” button. Controller recovers to factory set(factory set password is 0000), a new password can be reset now.

6. Button function

6.1 Holiday function

Description:

This function activates in night, solar liquid will flow from storage tank to collector to cool the tank, and therefore to prevent overheating problem of the solar system due to completely heated storage tank. The function is activated at night between 10 pm and 6 am, when the temperature of collector is 8 °C below the storage tank temperature (T2), solar circuit pump starts to work until the temperature of collector is 2 °C below the tank temperature, and then solar circuit pump is ceased.

Activate this function if:

- You intend to be absent for an extended period (holiday)
- No hot water is required for an extended period.

Note: The function is deactivated when the temperature on bottom of tank is below 35 °C.

Activate/ deactivate this function:

▶ Press  button for a long time until the signal of holiday function displays on the screen, and then holiday function is activated.

▶ Repress  button, signal disappears, holiday function is deactivated.

Note:

This function is only activated when you are not at home for long time, when you come back; please make sure to deactivate it.

6.2 Manual heating

Description:



Electrical heater, gas or oil boiler can be as back-up devices in a solar system, this controller can achieve constant temperature controlling, when temperature of top part tank (T3) is 3 °C below the preset switch-on temperature, back-up heating will be triggered. When the temperature on the top part tank (T3) rises up to the preset temperature, then heating is ceased.

Conditions for triggering manual heating function: the preset switch-on temperature of this function should be 3 °C higher than tank temperature.

Activate/deactivate the function:

▶ Press “Heating” button, temperature “60 °C” blinks on the screen.

▶ Press “+” “-” button to adjust switch-on temperature, adjustable range 10 °C~80 °C, factory set is 60 °C.

After 20 seconds, this function is activated, signal  displays on the screen, and heating signal  blinks also.

▶ Press “Heating” button again, to switch-off manual heating function.

Note: manual heating can only heat tank one time, after manual heating is triggered, when temperature of tank rises up to the preset temperature, manual heating ceases, and manual heating function will be deactivated automatically, if customer wants to heat again, you need redo according to above steps.

6.3 Temperature query function

Under standby status,

▶ Press “+” “-” button , you can check the value of temperature sensors T1~ T4, pump speed (n%), accumulative operation time of circuit pump (Hp), daily thermal energy (DKWH), accumulative thermal energy (KWH) or (MWH), time and date.

When checking temperature, T1 – T4 displays one by one, corresponding sensor signal  blinks. TST means the temperature of tank 1.

▶ Press “ESC” button, TST: tank temperature displays.

Note:

- Value of accumulative operation time of circuit pump (hp), Daily thermal energy (DKWH) and accumulative thermal energy (KWH) or (MWH) can only be checked after triggering of OHQM thermal energy measuring function.

7 Protection function

7.1. Memory protection

In case power failure occurs, controller keeps the parameter settings unchanged.

7.2 Screen protection

When no any press on button for 3 minutes, screen protection is activated automatically, and then LCD lighting lamp is switched-off. Through press any button to light LCD lamp again.

7.3 pump idling protection



Pump station monitors that no flow is in the circuit pipe within 3 minutes, then system pump is ceased, "P1" blinks on the screen, through this function, pump is prevented from damaging caused by pump idling.

: reasons for no flow :







- leakage problem in the system circuit pipe.
- block occuring on the blade of digital flow counter
- Switch-off the power supplier of controller to exit circuit pump protection function, recovery P1 to standby status.

8. Trouble shooting

8.1 Trouble protection





a. When there is a break or short circuit between the connection of temperature sensors, controller switches off the corresponding functions and no more output signals are given, at the same time error signals   show on the display. If controller does not work correctly, please check following points.

► Press “+” “-” button to check error code,   signal displays on the LCD screen

Error message	CODE Meaning	Cause of error	Error rectification
  T1 ---	T1 sensor problem	Sensor wiring short or open	Check resistance value or replace
  T2 ---	T2 sensor problem	Sensor wiring short or open	Check resistance value or replace
  T4 ---	T4 sensor problem	Sensor wiring short or open	Check resistance value or replace
	OHQM function is activated	T4 sensor not connected	Connect T4 sensor, deactivate functions(OHQM)

8.2 Trouble checking

The controller is a qualified product, which is conceived for years of continuous trouble-free operation. If a problem occurs, the most of causes is from the peripheral components but no relation with controller itself. The following description of some well-known problems should help the installer and operator to isolate the problem, so that the system can be put into operation as quickly as possible and to avoid unnecessary costs. Of course, not all possible problems can be listed here. However, most of the normal problems encountered with the controller can be found in the list below, only return the controller to seller when you are absolutely sure that none of the problems listed below is responsible for the fault.

Symptoms	Secondary symptoms	Possible cause	Procedure
Controller does not appear any functions at all	Display shows nothing, no display illumination	Controller power supply is interrupted or program is out of work	Check the controller power cable and fuse
The solar pump doesn't operate, despite the fact that switch-on conditions are satisfied	The pump symbol on the display blinks	Pump power supply is interrupted	Check the pump power cable
Solar circuit pump doesn't operate	The pump symbol in the display doesn't blink.  Lighted or  blinks	The maximum storage tank temperature (SMX1) has been reached The maximum collector temperature (EM) has been reached.	No fault
	  Tn --- Error message displays on the screen	Sensor fault (short circuit or open circuit)	Check values of every connected sensor; replace all defective sensors and /or cabling.
The solar pumps operated, despite the fact that the switch-on conditions are not satisfied	The pump symbol on the display blinks.	Holiday function or Frost protection function or tank re-cooling function is activated.	No problem, it is normal. If necessary to deactivate the corresponding functions.
One function can't be activated	no function selected in submenu	All inputs and outputs are used; inputs and outputs can't be used doubly.	No fault on controller



Warning! Remove the device from the mains supply before opening the case

A potentially defective sensor can be checked using an ohmmeter. To do this, the sensor must be disconnected, its resistance measured, and the value compared with the figures in the table below, small deviation ($\pm 1\%$) is acceptable.

PT1000 resistance value

°C	0	10	20	30	40	50	60	70	80	90	100	110	120
Ω	33620	20174	12535	8037	5301	3588	2486	1759	1270	933	697	529	407

NTC 10K B=3950 resistance value



°C	0	10	20	30	40	50	60	70	80	90	100	110	120
Ω	1000	1039	1077	1116	1155	1194	1232	1270	1309	1347	1385	1422	1460

9. Quality Guarantee

Manufacturer provides following quality responsibilities to end-users: within the period of quality responsibilities, manufacturer will exclude the failure caused by production and material selection. A correct installation will not lead to failure. When a user takes incorrect handling way, incorrect installation, improper or crud handling, wrong connection of sensor

in system and incorrect operation, the quality responsibility is invalid for them.
The warrantee expires within 24 months after the date of purchasing the controller.

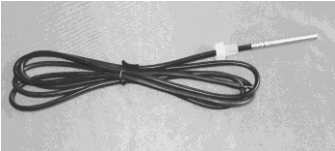
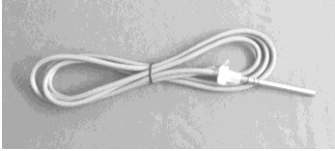
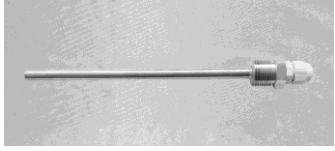
10. Accessories

<p>A01: sensor for collector</p>	<p>PT1000, $\Phi 6*50\text{mm}$</p>	
<p>A02: sensor for tank and pipe</p>	<p>NTC10K, B=3950, $\Phi 6*50$</p>	
<p>A05: stainless steel thermowell</p>	<p>Parameter: 1/2' OT, $\Phi 8*200$</p>	
<p>USB to RS485 Converter</p>		
<p>Digital flow meter</p>	<p>(1-20L/min)</p>	
<p>SR802: unit for high pow</p>	<p>Dimension:100mmx100mmx65 mm Power supply: AC180V ~ 264V, 50/60Hz Suitable power: $\leq 4000\text{W}$ Available ambient temperature: $-10 \sim 50^{\circ}\text{C}$ Waterproof grade: IP43</p>	

SR802 connection diagram:

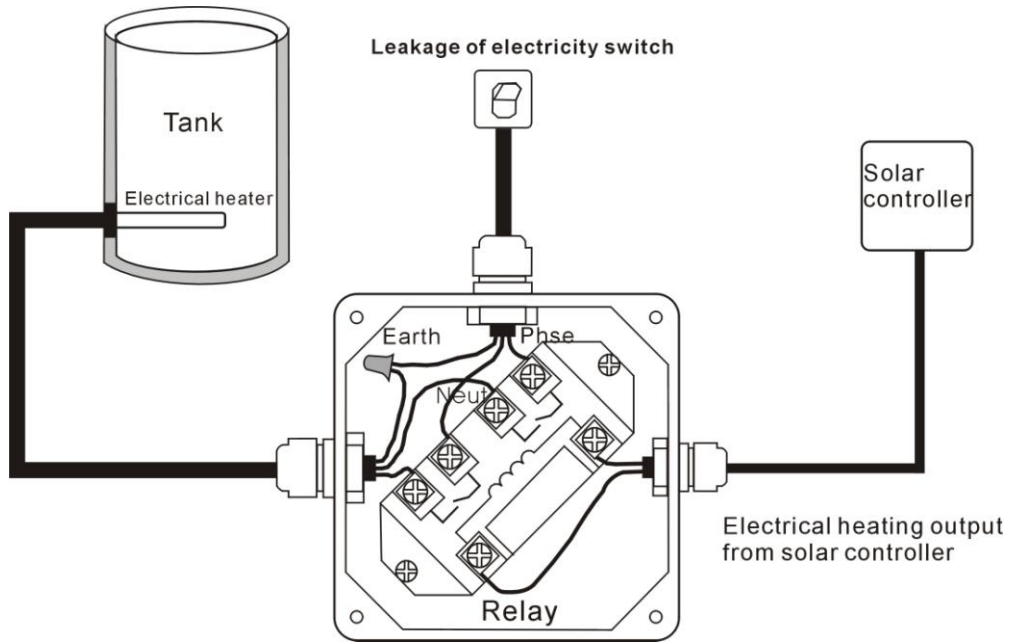

Note: switch-off power, and perform by profession installer