



SP25 Manual

Content

| | |
|--------------------------|---|
| General information..... | 1 |
| Product description..... | 2 |
| System description..... | 3 |
| Fault message..... | 5 |
| Packing list..... | 5 |

General information

1 About this manual

This manual book describes the installation, functions and operation rules of our intelligent controller series for solar water heating control system. When install with other applications on this system, such as solar collector, pump station, and storage, please follow the instruction of correlative suppliers. The installation, electrical connection, adjustment and maintenance should be carried out by a qualified specialist.

2 Safety rules

- The controller can't be installed in the room where easily inflammable and explosive mixtures (e.g. gas or oil) are present or may occur.
- The controller can't be installed in the location which exceeds its allowable environment condition.
- **All operations which require opening the controller are only to be taken without the power supply. And the operation should be carried out by a qualified specialist.**
- *Before connecting the electrical wire, make sure that the power supply matches the required parameter. All devices connected to the controller must match the technical parameter of it.*
- Once the controller is damaged or failure to work, please take it out of system and inform the supplier.

3 Liability waivers

- Improper installation or operation can cause damages to material and persons. The manufacturer cannot monitor the compliance with these instructions or the circumstances and methods used for installation, operation, utilization and maintenance of this device. Damage by mishandling or improper installation on customer site is immediately leading to warranty exclusion.
- As faults can never be excluded, we don't offer a guarantee for the completeness of the drawings and texts of this manual, they only represent some examples. They can only be used on own risk. No liability is assumed for incorrect, incomplete or false information and the resulting damages.
- The manufacturer preserves the right to put changes to product, technical data or installation and operation instructions without prior notice.

4 About Sensors











- Only original equipped Pt1000 temperature sensors can be matched the solar collector. It is equipped with 1.5m silicone wire and suitable for all kinds of weather conditions. They can resist the temperature up to 280 °C. There is no need to distinguish the positive and negative charges when connect them to the controller.
- Only original equipped NTC10K temperature sensors can be matched the storage and pipeline. It is equipped with 1.5m PVC wire. They can resist the temperature up to 105 °C. There is no need to distinguish the positive and negative charges when connect them to the controller.
- All sensor wires can carry low voltage. In order to avoid inductive effects, the wires must not be laid close to 230 V or 400 V cables (The min. distance should be 100mm).
- If external inductive effects exist, e.g. heavy current cables, overhead train cables, transformer substations, radio and television devices, amateur radio stations or microwave devices, then the wires for the sensors must be adequately shielded.
- Sensor wires can be extended to a maximum length of 100m. When it is extended to 50m, use 0.75mm² wire. When it is extended to 100m, use 1.5 mm² wire.

Product description

1 Main technical data













- Dimension: 186x140x41mm
- Input voltage: 220V ~ 240V AC or 100V ~ 120V AC
- Power: 3W
- Accuracy of temperature measuring: ± 1
- Range of temperature measuring: PT1000: 0 ~ 199 NTC 10K: 0 ~ 99
- Input signals:
 - 1 x PT1000 sensor temperature probe 500 , silicon cable 280 ;
 - 2 x NTC10K sensor temperature probe 135 , PVC cable 105
- Output signals:
 - 1 x Auxiliary heating output (Max. load current: 12A)
 - 2 x Relay output (Max. load current: 3A)
- LCD-display
- Range of environment temperature: -10 ~ 50
- Water protection grade: IP40

2 Operation regulations

- When connect to power, the default mode is system working mode.
- Press  button to start the system data set mode. Press it again to convert to different set choice. Every choice is corresponding to different signal display. Please see the description of signals in the following instruction.
 Press  and  buttons to adjust the set value, press  button to switch on correlative function or confirm the current set value.
 Press  button to cancel correlative function or cancel the current set value, then start the system working mode.
- On the system data set mode, if not press any button within 15 seconds, the system will cancel the current set value, start the system working mode.
- On the system working mode, press  button to switch on the auxiliary heating. Press  button to switch off the heat auxiliary heating.
- On the system working mode, press  button for 2 seconds to switch on or switch off the R1 output handily. Press  button for 2 seconds to switch on or switch off the R2 output handily.
- On the system working mode, press  button for 2 seconds to recover to the factory default.

3 Wire connection



| | | | | | | | | | | | |
|---|---|---|---|---|---|---|---|---|---|---|---|
| L | N | ⏏ | Elec. Heating | | Outlet | | | | Inlet | | |
| | | | L | N | R1 | R2 | T1 | T2 | T3 | | |
|  |  |  |  |  |  |  |  |  |  |  |  |

System description

System 1

The standard split pressurized solar water heating system with 1 collector array and 1 storage. Use electrical heater as auxiliary heating device.

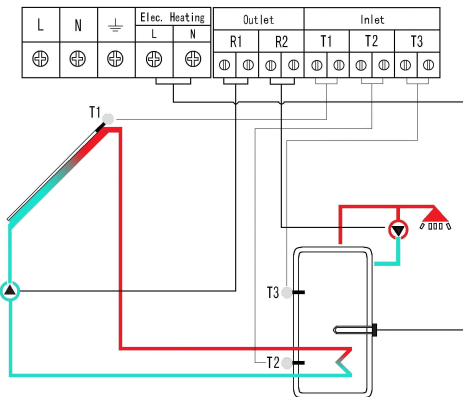

| Relay output | Note |
|---------------|-----------------------|
| Elec. Heating | Elec. heater |
| R1 | Pump 1 |
| R2 | Pump 2 |
| Sensor input | Note |
| T1 | Temp. of Collector |
| T2 | Temp. of Storage base |
| T3 | Temp. of Storage top |

| Signal | Function | Factory setting | Value arrange | Description |
|--------|--|---|---------------|---|
| | System choice | 1 | 1-2 | System 1 |
| | Time display | | | Display the current time |
| | Three time periods on auxiliary heating | 04:00-05:00 10:00-10:00 17:00-22:00 | 00:00-23:50 | Adjust the auto. working time periods of auxiliary heating |
| | Three time periods on hot water output circulation | 06:00-08:00 10:00-10:00 19:00-21:00 | 00:00-23:50 | Adjust the auto. working time periods of hot water output circulation |
| | Storage keeping temp. | 60 | 45-75 | Adjust the referenced temp. of auxiliary heating |
| | Switch-on temp. difference | 8 | 5-20 | Adjust the desired switch-on temp. difference |
| | Switch-off temp. difference | 4 | 2-12 | Adjust the desired switch-off temp. difference |
| | Overheating protection of storage | 80 | 50-95 | When the storage reaches the desired overheating protection temp., temp. difference circulation will be switched off. |
| | System frost protection | 3 | 2-8 | When the collector temp. is lower than the desired frost protection temp., this function will be activated. |
| | Holiday function | | | This function will be activated when a holiday is planed or when there is no need to use hot water for a long time. |
| | System overheating protection | 130 | | When the collector is overheating, the system stops working, which to avoid the accessories to be destroyed. |
| | Anti-bacteria protection | | | To avoid the bacteria occur, the system takes the bacteria-killing process periodically. |

System 2

The standard split pressurized solar water heating system with 1 collector array and 1 storage. Use gas boiler as auxiliary heating device.

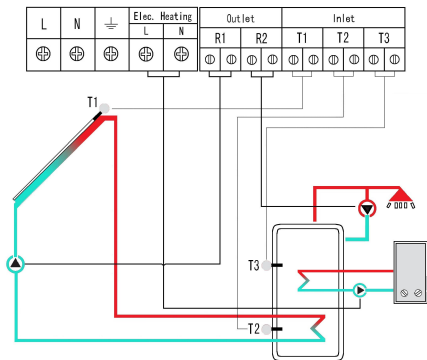

| Relay output | Note |
|---------------|-----------------------|
| R1 | Pump 1 |
| R2 | Pump 2 |
| Elec. heating | Gas boiler |
| Sensor input | Note |
| T1 | Temp. of Collector |
| T2 | Temp. of Storage base |
| T3 | Temp. of Storage top |

| Signal | Function | Factory setting | Value arrange | Description |
|--------|--|---|---------------|---|
| | System choice | 1 | 1-2 | System 1 |
| | Time display | | | Display the current time |
| | Three time periods on auxiliary heating | 04:00-05:00 10:00-10:00 17:00-22:00 | 00:00-23:50 | Adjust the auto. working time periods of auxiliary heating |
| | Three time periods on hot water output circulation | 06:00-08:00 10:00-10:00 19:00-21:00 | 00:00-23:50 | Adjust the auto. working time periods of hot water output circulation |
| | Storage keeping temp. | 60 | 45-75 | Adjust the referenced temp. of auxiliary heating |
| | Switch-on temp. difference | 8 | 5-20 | Adjust the desired switch-on temp. difference |
| | Switch-off temp. difference | 4 | 2-12 | Adjust the desired switch-off temp. difference |
| | Overheating protection of storage | 80 | 50-95 | When the storage reaches the desired overheating protection temp., temp. difference circulation will be switched off. |
| | System frost protection | 3 | 2-8 | When the collector temp. is lower than the desired frost protection temp., this function will be activated. |
| | Holiday function | | | This function will be activated when a holiday is planed or when there is no need to use hot water for a long time. |
| | System overheating protection | 130 | | When the collector is overheating, the system stops working, which to avoid the accessories to be destroyed. |
| | Anti-bacteria protection | | | To avoid the bacteria occur, the system takes the bacteria-killing process periodically. |

Fault message

Note 1:

If there are faults on the controller, please do not repair it by yourself. It should be taken by the qualified specialist.

If there is a problem with the controller or temperature sensor, the fault signals will be displayed on the screen as the following:

| Fault signal | <FF> | <FE> |
|----------------|--|---|
| Possible cause | The inside of sensor or the connection wire between sensor and controller is open circuit. | The inside of sensor or the connection wire between sensor and controller is short circuit. |
| Solution | Check the connection or resistance value of the sensor, replace it on necessary. | |

Note 2:

Use Ohmmeter to check the resistance value of sensors. According to the comparative with the standard value, the fault sensor can be checked out. When check the resistance value, the sensor should be cut off from the system. Small error can be allowed when compare the test value with the standard value.

PT1000 Resistance value:

| | | | | | | | | | | | | | |
|--|------|------|------|------|------|------|------|------|------|------|------|------|------|
| | 0 | 10 | 20 | 30 | 40 | 50 | 60 | 70 | 80 | 90 | 100 | 110 | 120 |
| | 1000 | 1039 | 1077 | 1116 | 1155 | 1194 | 1232 | 1270 | 1309 | 1347 | 1385 | 1422 | 1460 |

NTC 10K B=3950 Resistance value:

| | | | | | | | | | | | | | |
|--|-------|-------|-------|------|------|------|------|------|------|-----|-----|-----|-----|
| | 0 | 10 | 20 | 30 | 40 | 50 | 60 | 70 | 80 | 90 | 100 | 110 | 120 |
| | 33620 | 20174 | 12535 | 8037 | 5301 | 3588 | 2486 | 1759 | 1270 | 933 | 697 | 529 | 407 |

Packing list

| No. | Item | Specification | Quantity |
|-----|---------------|---------------|----------|
| 1 | Controller | 186×140×41mm | 1 pc |
| 2 | Power line | | 1 pc |
| 3 | PT1000 sensor | 1.5m | 1 pc |
| 4 | NTC sensor | 1.5m | 2 pcs |
| 5 | Fixed screw | | 1 bag |
| 6 | Manual | | 1 pc |