



# SP116 Manual

# CONTENT

## Part 1: Operation instruction

General information .....	1
Product description .....	2
Function description.....	5
Fault message .....	10

## Part 2: Installation instruction

General information .....	11
Mounting.....	12
Electrical wiring.....	14
Commissioning.....	15
Replacing pump.....	16
Packing list.....	18

# Part 1: Operation instruction

## . General information

### 1. About this manual

This manual describes the installation, function and operation of an integrated solar work station, which is suitable for split pressurized solar heating system. Before installing and operating the device, please read the following information carefully.

### 2. Safety regulations

- ◆ Installation, commissioning and maintenance of the device may only be performed by professional personal.
- ◆ All operations that require opening the device are only to be conducted cleared from the power supply. All safety regulations for working on the power supply are valid.
- ◆ The device must not be installed in rooms where easily inflammable material (e.g. gas or oil) mixtures are present or may occur.
- ◆ Before connecting the work station, make sure that the energy supply matches the specifications of the device. Protect the solar station against overloading and short-circuiting.
- ◆ All devices connected to the work station must conform to the technical specifications of the device.
- ◆ As soon as it becomes evident that safe operation is no longer possible, please immediately take the device out of operation.
- ◆ Without lightning rod, please don't use this device during a thunderstorm.

### 3. Liability waiver

- ◆ Improper installation or operation can cause damages to material and persons. The manufacturer cannot monitor the compliance with these instructions or the circumstances and methods used for installation, operation, utilization and maintenance of this device. Damage by mishandling or improper installation on customer site is immediately leading to warranty exclusion.
- ◆ As faults can never be excluded, we don't offer a guarantee for the completeness of the drawings and texts of this manual, they only represent some examples. They can only be used on own risk. No liability is assumed for incorrect, incomplete or false information and the resulting damages.
- ◆ The manufacturer preserves the right to put changes to product, technical data or installation and operation instructions without prior notice.

### 4. Symbols used



**Danger:** Failure to observe these instructions can lead to injury of persons or safety risks.



**Attention:** Failure to observe these instructions can result in damage to the product or environment.



**Note:** Useful information and instructions.

ì **Operation steps:** Indication of operation steps.

## . Product information

### 1. System description

The solar circulation pump (P1) is activated as soon as the temperature difference between the collector array (T1) and the storage (T2) are reached. If the temperature difference between the collector array (T1) and storage (T2) drops below the switch-off temperature difference, or the storage (T3) reaches its maximum temperature, the solar pump (P1) will be switched off.

T3 is used to measure the temperature of the top part of storage. If the turning-on condition for auxiliary heating is reached, the auxiliary heating will be activated.

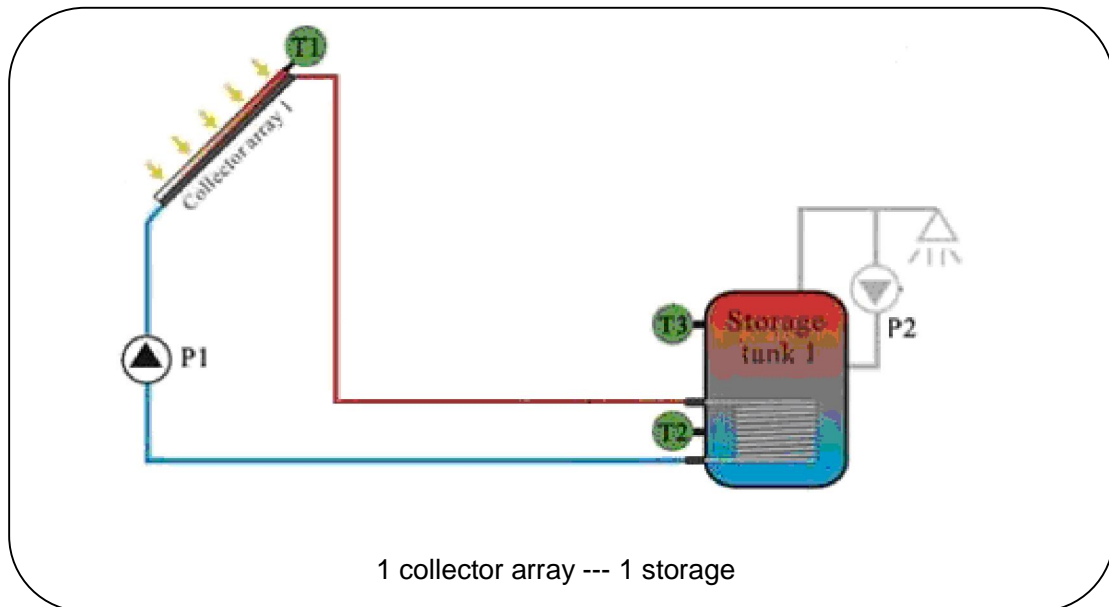

T1: Temperature sensor for collector array

T2: Temperature sensor in bottom part of storage

T3: Temperature sensor in top part of storage

P1: Solar circulation pump

P2: Solar circulation pump



**Danger:** If there is only one temperature sensor in water storage (usually in bottom part T2), it is possible that the auxiliary heating function will not be activated or deactivated at a right time, because the water temperature in top part of the storage (T3) cannot be measured. In this case, if you still want to use auxiliary heating function, control program will automatically take the signal from bottom temperature sensor (T2) instead of T3. However, water in top part of storage might often be overheated. It may cause damages to material and persons. So it is highly recommended not to use auxiliary heating in such a case.



**Note:** To lock this function, please press “Choose Function” button until the signal “” appears on the screen (see details in 3.6 Forbid/Permit using auxiliary heating).

## 2. Components

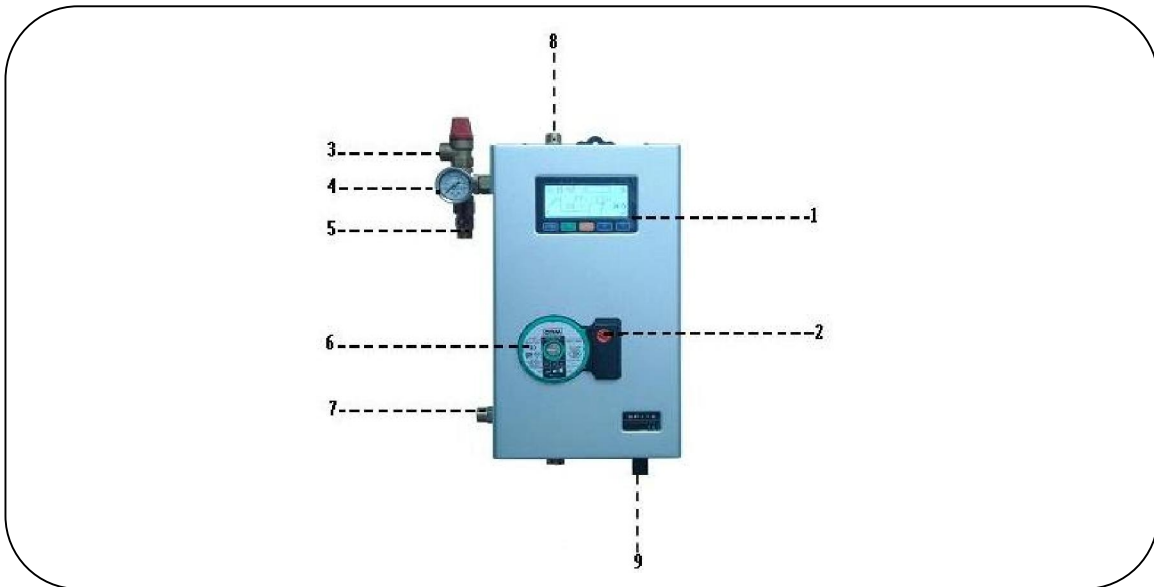













No	Components	Function description
1	Operating screen (LCD)	Display operating menu.
2	Pump speed regulation	Three speed levels available, offers different flow rate.
3	Safety valve	Protect the system against over-pressure
4	Manometer	Display system pressure (Max. 10 bar, normal working pressure is approx. 2 bar)
5	Filling and flushing connector	Filling medium, flushing the pipeline
6	Circulation pump	WILO Star RS 15/6 (110V or 220V)
7	Expansion vessel connector	Connect expansion vessel. Expansion vessel balance the system pressure.
8	Return flow	Copper material, left side. Max. working temperatur 150 , screw thread 1/2' (DN15) as standard
9	Input and output signals	Temperature sensors, power cord and other outputs.

## 3. Technical data

Dimension	380x220x140mm
Input voltage	200V ~ 240V AC or 100V ~ 120V AC
Power	3W
Accuracy of temperature measuring	±1
Range of temperature measuring	PT1000 : 0 ~ 199 NTC10K: 0 ~ 99
Input signals	1 x PT1000 sensor temperature probe 500 , silicon cable 280 ; 2 x NTC10K sensor temperature probe 135 , PVC cable 105

Output signals	1 x Auxiliary heating output (Max. load current: 10A) 2 x Relay output (Max. load current: 3A)
System design pressure	10 bar
Safety valve response pressure	6 bar
WILO pump	SR15/6
Ambient temperature	-10~50
Water protection grade	IP40

#### 4. Display signals

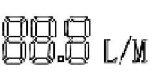
	Weekday: 7 days of week can be set (e.g. Week 1 means "Monday").
	Time: Setting hours and minutes.
	Time-controlled auxiliary heating: Setting three heating time periods.
	Time-controlled hot water circulation: Setting three time periods.
	Storage temperature: As turning-on/off temperature value for auxiliary heating.
	Frost protection.
	Overheating protection for storage.
	High temperature protection for solar collector.
	Holiday function.
	Switch on/off auxiliary heating manually.
	Forbid/permit using auxiliary heating.
	Reset.
	Temperature display.
	Flow rate display.

## Functions and operation





**Danger:** Before connecting the power supply, make sure that the storage, solar collector, solar work station and all temperature sensors are good connected!



**Note:** For safety, auxiliary heating is locked at delivery state. The single “” displays on the screen. If you want to use this function, please see operation: 3.6 Forbid/Permit using auxiliary heating.

### 1. Setting week and time

After power supply is switched on, please firstly set the week of the system.

- ì Press “System Setting” button until the signal “” displays on the screen.
- ì Press “+” “-” button to set weekday. (range: 0-6, e.g. 1 means “Monday”)
- ì Press “Confirm” button to save the setting; press “Cancel” button to cancel the setting.
- ì Press “System Setting” button again until “” displays on the screen.
- ì Press “+” button to set hour, press “-” button to set minute.
- ì Press “Confirm” button to save the setting; press “Cancel” button to cancel the setting.

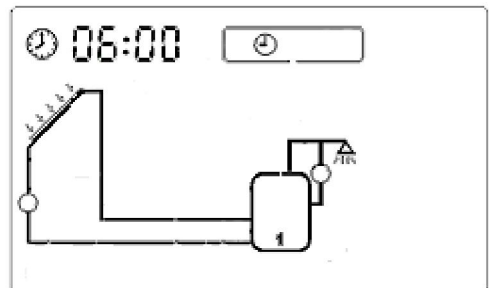
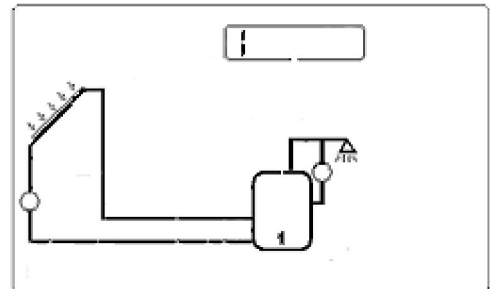

### 2. Time-controlled auxiliary heating

Solar thermal system can be combined with electric boiler or gas/oil boiler. The system is supported with a default program which can be customized to meet your individual needs. You can create a timer program with up to three time periods to heat the water to a desired value. During the three preset time periods, auxiliary heating starts working, when the water temperature in top part of storage (T3) is below preset turning-on temperature, and it stops working, when T3 exceeds the required temperature.



**Note:** Default setting: the first time period: 04:00 turning-on, 05:00 turning-off; the second time period: 10:00~10:00; the third time period: 17:00 turning-on, 22:00 turning-off.

- ì Press “System Setting” button until the signal “” appears.
- ì Press “+” “-” button to set the start time of the first time period. Press “+” to adjust hours, press “-” button to adjust minutes.

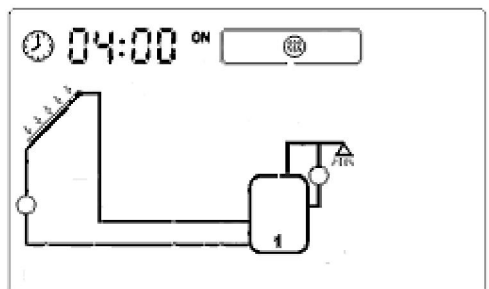

- ì Press “Confirm” button to save the settings, press “Cancel” button to cancel the settings.
- ì Immediately after setting the first time period, the display enters into the operating menu of next time period.
- ì Perform like above steps, the other two time periods can be set.



**Note:** If you want to shut off one of the three time periods, you can set a same value for both start time and ending time, e.g., you can set both the start and ending time of second time period at 10:00 am.

### 3. Time-controlled circulation function

This function needs an extra circulation pump (P2). You can set up a timer program with up to three time periods. This pump can be triggered at times when hot water will be needed.



**Note:** Within the preset three time periods, pump P2 always stops for 15 minutes after operating for 3 minutes.



**Note:** Default setting: the first time period: 06:00 turning-on, 08:00 turning-off; the second time period: 10:00~10:00; the third time period: 19:00 turning-on, 21:00 turning-off. Three time periods should be set within one day (24 hours).

- ì Press “System Setting”, until “” displays on the screen.
- ì Press “+” “-” button to adjust the start time and end time of first time period. Press “+” button to adjust hours, press “-” button to adjust minutes.
- ì Press “Confirm” button to confirm the setting, press “Cancel” button to cancel this setting.
- ì Immediately after setting the first time period, the display enters into the operating menu of next time period.
- ì Perform like above steps, the other two time periods can be set.

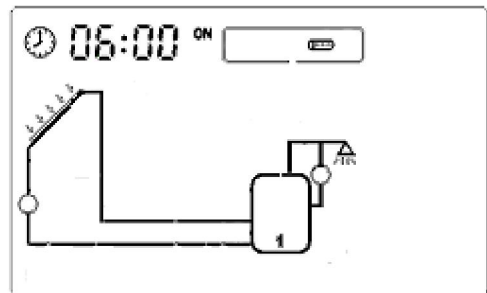

**Note:** If you want to shut off one of the three time periods, you can set a same value for both start time and ending time, e.g., you can set both the start and ending time of second time period at 10:00 am.

### 4. Temperature difference circulation function

The solar control program works on the principle of temperature difference circulation. Solar pump P1 is triggered, as soon as the preset temperature difference between collector and storage is reached.

- ì Press “System Setting” button, until “” displays on the screen.
- ì Press “+” “-” button to adjust storage temperature. Default value: 60 , setting range: 45~75 .
- ì Press “Confirm” button to save the setting. Press “Cancel” button to cancel this function.
- ì At the same time the menu shows “10 ”, the default value of

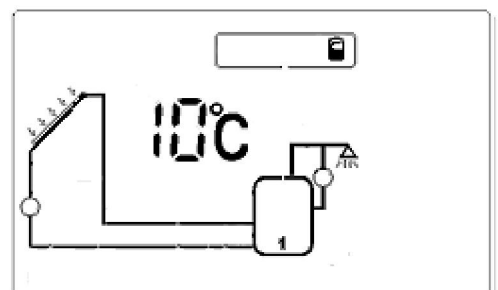



switch-on temperature difference.

- ì Press “+” “-” button to adjust it. Setting range: 5~20 .
- ì Press “Confirm” button to save the setting. Press “Cancel” button to cancel this function.
- ì Then the menu shows “5”, the default value of switch-off temperature difference.
- ì Press “+” “-” button to adjust it, adjustable range: 2~12 .
- ì Press “Confirm” button to confirm the setting. Press “Cancel” button to cancel the function.



**Note:** Between 60~70 scale can form more easily; we usually set the storage temperature at 60 .



## 5. Switching on/off auxiliary heating manually

If you want to use warm water immediately, but the water temperature doesn't reach the desired value, you can switch on/off the auxiliary heating manually.

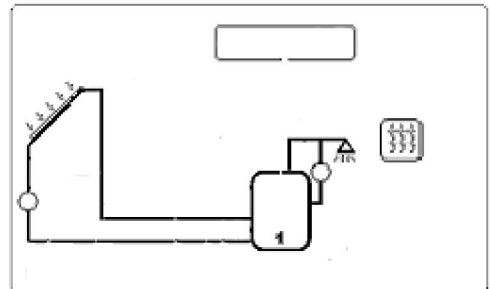
- ì Press “confirm” button, until “” displays on the screen to switch on auxiliary heating manually.
- ì Press “Cancel” button to switch off auxiliary heating manually.



## 6. Forbid/Permit using auxiliary heating

- ì Press “System Setting” button, until “” displays on the screen.
- ì Press “Confirm” button to save the setting and forbid auxiliary heating.
- ì Press “System Setting” button until “” displays on the screen.
- ì Press “Cancel” button to cancel the setting and permit auxiliary heating.

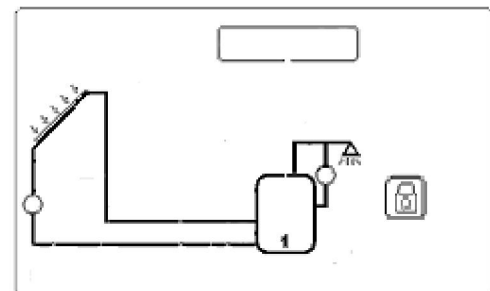

**Note:** When forbid auxiliary heating, customer can't switch on/off auxiliary heating manually and time-controlled auxiliary heating function is also automatically deactivated.

## 7. Frost protection

In winter, when the temperature of collector drops below the preprogrammed starting temperature of frost protection (default value 5 ), solar pump P1 starts working. When collector temperature exceeds the switch-off temperature of frost protection, pump P1 stops working and the system exits frost protection.

- ì Press “System Setting”, until “” displays on the screen.
- ì Press “+” “-” button to adjust the temperature of frost protection. Setting range: 3 –10 .

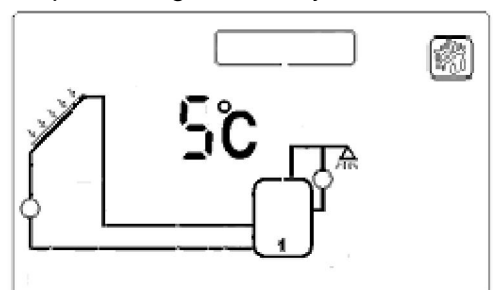

- ì Press “Confirm” button to confirm the setting, press “Cancel” button to deactivate this function.

## 8. Storage overheating protection

To avoid overheating of water storage, system is supported with an overheating protection function. When the temperature of storage (T3) is higher than the maximum temperature, even the condition of temperature difference circulation is reached, solar pump is still forbidden to operate.

- ì Press “System Setting” button, until  displays on the screen.
- ì Press “+” “-” button to adjust the maximum storage temperature. Default value: 80 , setting range: 60–90 .
- ì Press “Confirm” button to confirm the setting, press “Cancel” button to quit the function.

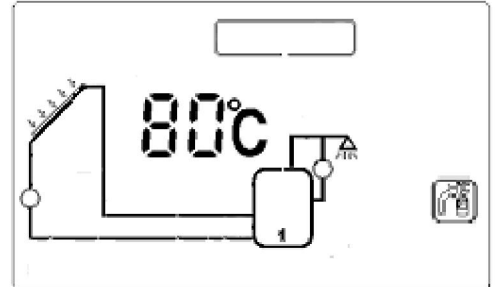

## 9. High temperature protection of solar system

When collector temperature reaches 115 , and meanwhile the storage doesn't reach the max. temperature, the high temperature protection function of solar system will be activated.

- ì Press “System Setting”, until  displays on the screen.
- ì Press “+” “-” button to adjust the maximum collector temperature. Default value: 115 , setting range: 100–130 .
- ì Press “Confirm” button to confirm the setting, press “Cancel” button to quit this function.

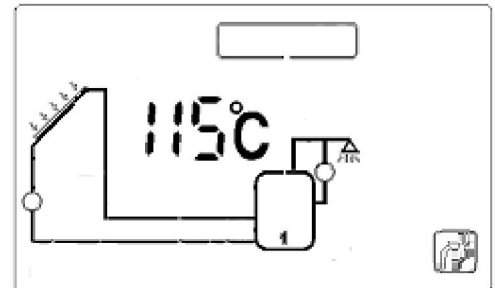

## 10. Holiday function

If you intend to be absent for an extended period (holiday), or hot water is not required for an extended period, you can activate the holiday function. This function is activated nightly ( 22 : 00-06 : 00 ) to re-cool the storage and to prevent high thermal loads of the solar system due to completely heated storage.

- ì Press “System Setting”, until “” displays on the screen, it indicates that the function is active.
- ì Press “Confirm” button to confirm this setting. Press “Cancel” button to deactivate this function.



**Note:** When using holiday function, system will lock auxiliary heating automatically.

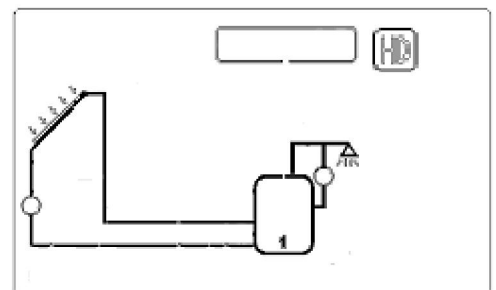

## 11. Anti-bacteria protection

To safeguard the water hygiene, solar system will monitor the storage temperature. If the temperature never reaches 70 in every 7 days, auxiliary heating will be activated automatically and heats the storage temperature to 70 .

## 12. Collector emergency cut-off

When the temperature of collector reaches or exceeds 120 , in order to prevent evaporation of heat medium liquid and protect other components of solar system, solar circulation pump will be stopped compulsively, until the temperature of collector gets lower.

## 13. Memory function

In case of power failure, solar control system is able to remain the preset parameters unchanged.

## 14. Reset Function

If necessary, all the settings (except time setting) can be reset to the factory settings.

- ì Press “System Setting” button, until “AUTO” displays on the screen.
- ì Press “Confirm” button, all of parameters will be reset to factory settings.

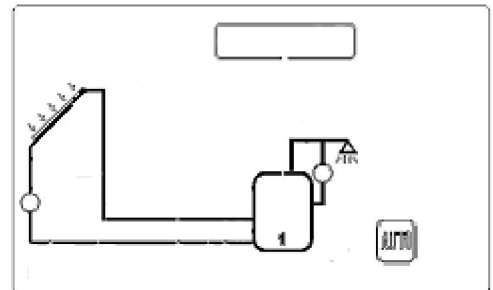

## 15. Manual operations

Customers can monitor the flow rate anytime by viewing the signal “00.0 L/M” on main operating menu. And when there are no other operations and it returns to main menu, they can also activate some functions by pressing different buttons directly.

- ì Press “Confirm” button 2 second to switch on/off solar collector pump (P1) manually.
- ì Press “Cancel” button 2 second to switch on/off solar hot water circulation pump (P2) manually.
- ì Press “+” “-” button repeatedly to check the temperature values in different part of solar system.

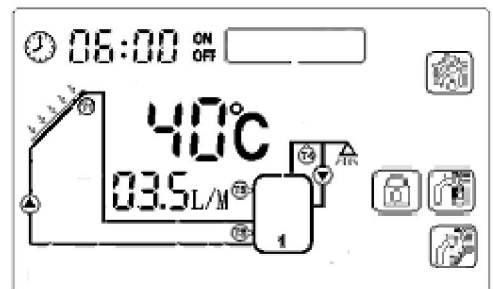

## Fault messages



**Danger:** Never try to repair the solar pumping station yourself! Consult a specialist in case of an error.

The following table explains the error messages and corresponding handling indication. Most of the problems can be found in the list below.

No.	Familiar problem	Possible reason	Solution
1	Pump works but no flow rate displays.	There is probably too much air in the pipeline.	Replenish heat medium liquid and exhaust the air.
2	System has temp. difference but pump doesn't work.	Storage reaches max. temp.	When storage temperature drops, pump starts working.
		Solar collector reaches its max. temp..	When collector temperature drops, pump starts working.
3	Auxiliary heating doesn't work.	Auxiliary heating is forbidden.	Activate it manually.
		Temperature sensor has broken circuit or short circuit.	Check sensor connection and make the wiring again.
4	Auxiliary heating still operates at 23:00.	Anti-bacteria function starts up.	It's normal.
5	System pressure drops.	There is air leakage in solar system.	Check the pipeline and exhaust the air.
6	Pump works but system doesn't have temp. difference, meanwhile auxiliary heating function starts up.	Frost protection function is activated,  signal blinks.	After collector temperature rises, pump stops working.

The solar work station SP116 shows error messages in the main operating menu if there is a problem with temperature sensor.

Error message	meaning	Possible cause	Error rectification
<FF >	There is broken circuit with sensor connections.	Sensor wiring interrupted, not connected or short circuit.	Check resistance value, replace sensor if necessary.
<FE >	There is a short circuit with sensor connections.	Sensor wiring interrupted, not connected or short circuit.	Check resistance value, replace sensor if necessary.



**Note:** A potentially defective sensor can be checked using an ohmmeter. To do this, the sensor must be disconnected. Its resistance value can be compared with the figures below, small deviation is acceptable.

### PT1000 resistance value

	0	10	20	30	40	50	60	70	80	90	100	110	120
	1000	1039	1077	1116	1155	1194	1232	1270	1309	1347	1385	1422	1460

### NTC 10K B=3950 resistance value

	0	10	20	30	40	50	60	70	80	90	100	110	120
	33620	20174	12535	8037	5301	3588	2486	1759	1270	933	697	529	407

## Part 2: Installation instruction

### General information

#### 1. Safety

Before installing the device, please read this manual carefully. Please note that the installation must be executed according to relevant technical rules. The installation must be adapted to the conditions provided by the customer. Damages by improper using or incorrect modification of installation and construction are on costumer site.



**Attention:** This manual is for trained personals only!



**Note:** As faults can never be excluded, we don't offer a guarantee for the completeness of the drawings and texts of this manual, they only represent some examples.

#### 2. Input and output signals

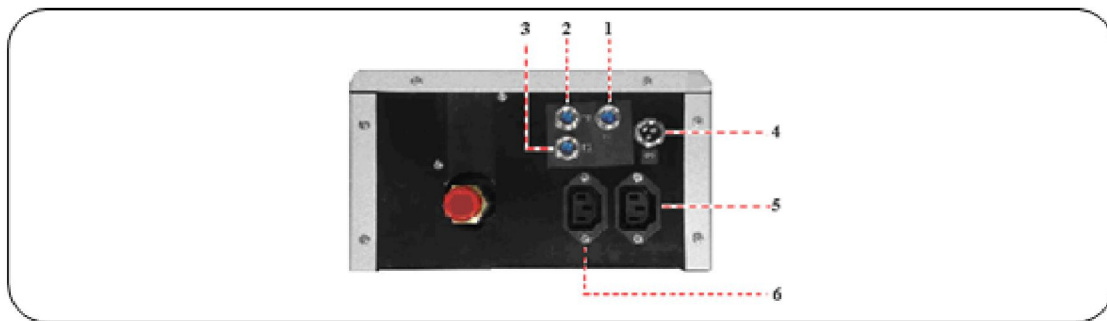

1	T1 connector	4	P2 circulation pump connector
2	T2 connector	5	Power plug connector
3	T3 connector	6	Auxiliary heating connector

#### 3. System demonstration

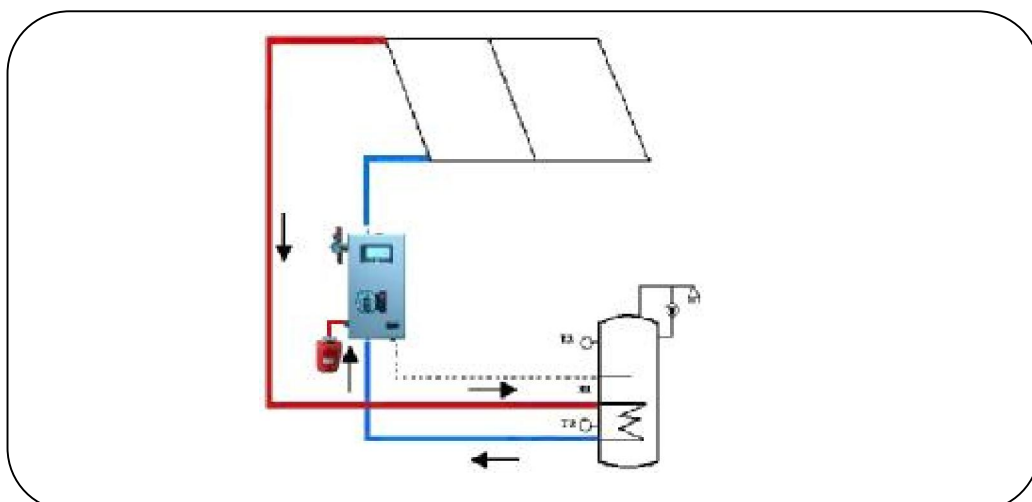

## Mounting

1. Open the package carton and take out the solar control system carefully.

Determine the mounting position of the solar control system, considering the mounting place for expansion vessel. See picture 1.

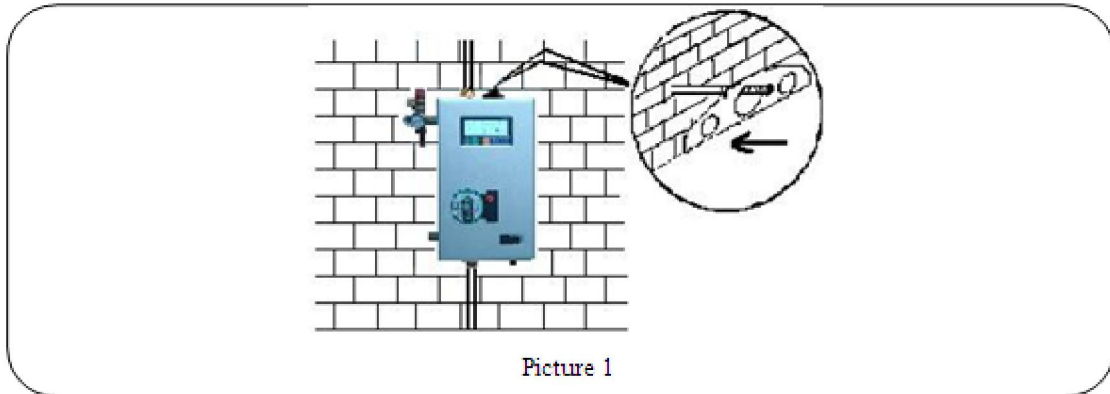

2. Drill the holes for dowels, put the dowels into the holes, fixed the solar control system on the wall using fastening screws. The solar control system must be vertically installed. See picture 2.

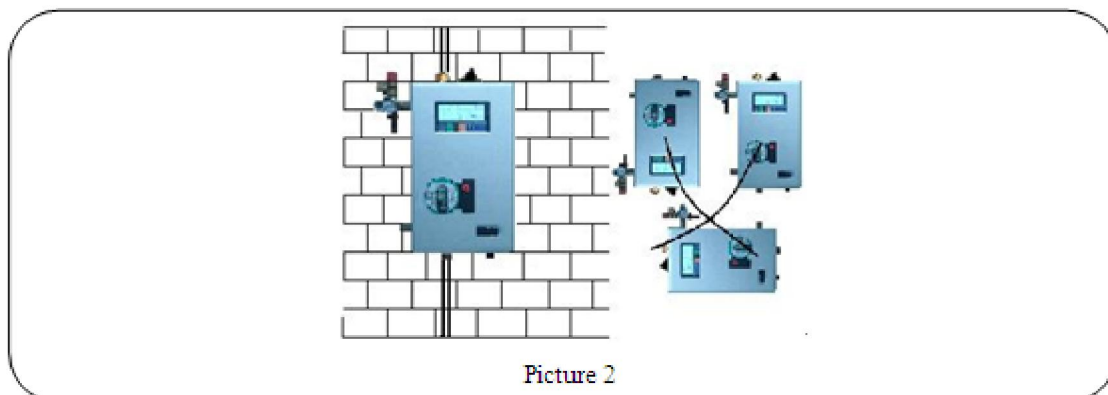

3. Use two wrenches to connect the pipes. See picture 3.

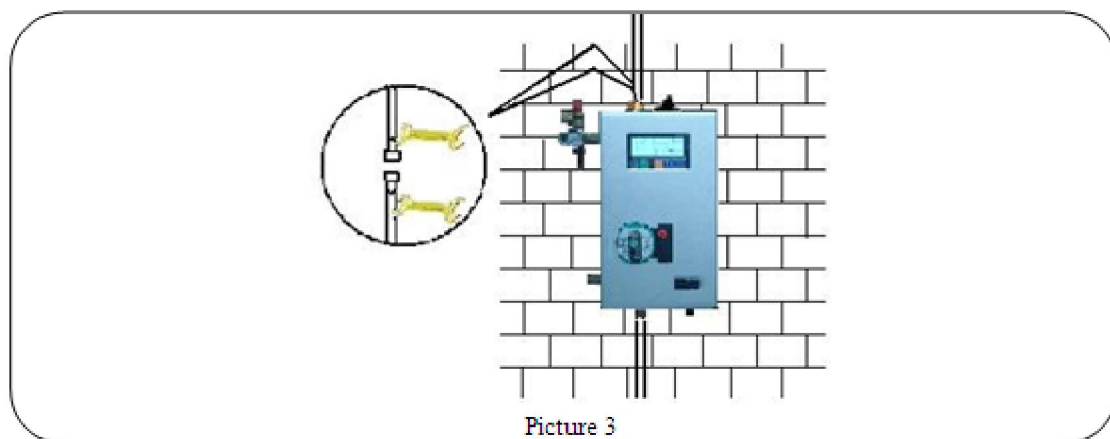

4. Install an auto air vent next to the interface of solar collector. See picture 4.

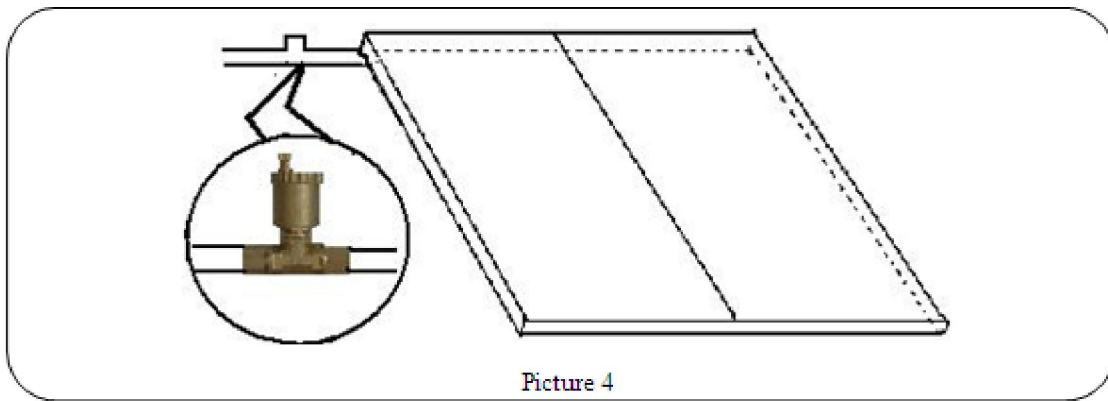

Picture 4

5. Connect filling connector (5) with a separate pump. Install a 3-way ball valve below the solar control system for draining (drain valve) and open ball valve. See picture 5. Until there is medium overflowing from ball valve, please close the ball valve. (There is already a non-return valve installed inside the solar control system between filling and drain valve.)

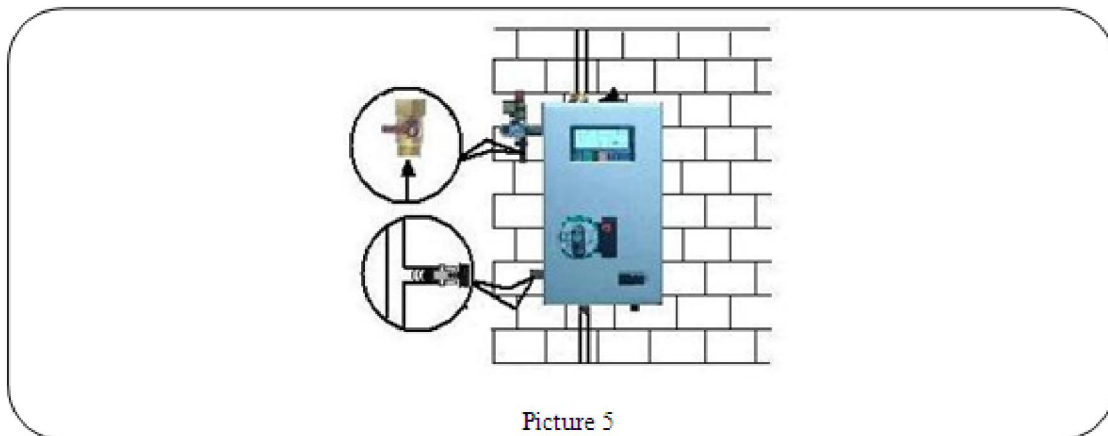

Picture 5

6. After above steps, connect an expansion vessel to the connector (7). See picture 6.

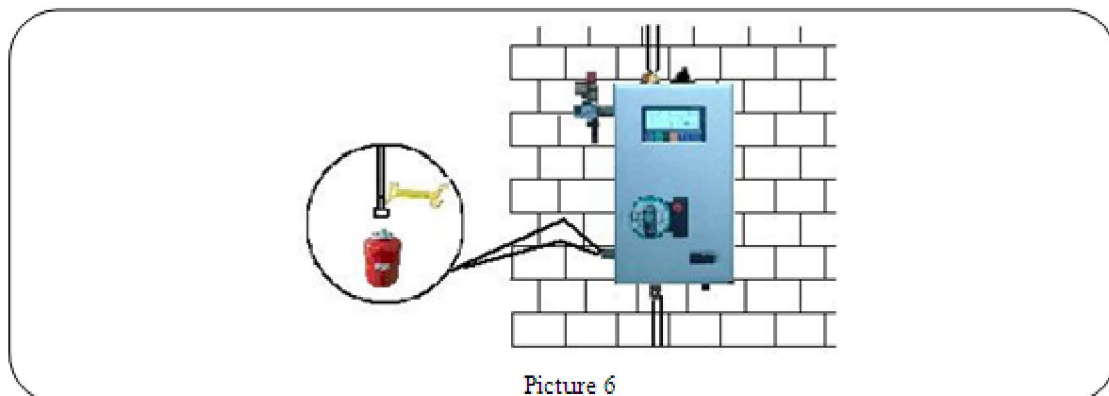

Picture 6

### 7. Filling the system

Connect a separate pump to the filling valve with pressure hose.

Open the filling and drain valve, fill the system with the separate pump. Heat medium liquid (usually use water-glycol mixture as heat medium, 50% glycol and 50% water) will be pumped into the system until it is filled up. Close the drain valve and continue to fill the system with medium liquid until the system pressure is not lower than 2 bar (the system pressure can be read from the manometer).

Close the filling connector and switch off the pump.

## Electrical wiring

1. Insert the temperature sensors into storage (T2, T3) and solar collector (T1). Connect these sensors to the solar control system SP116 correspondingly. See picture 7.

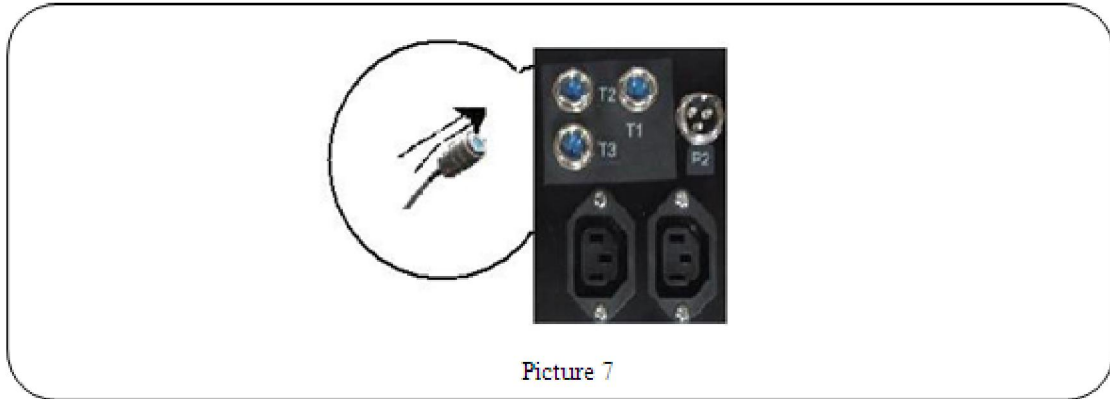

Picture 7

2. Connect auxiliary heating wire if available. Cable (coffee) for the “L”, cable (blue) for “N” line, cable (yellow-green) for the ground wire.

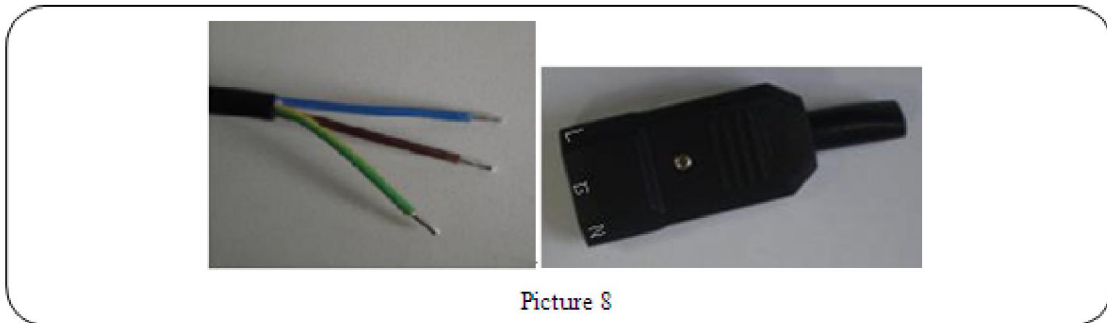

Picture 8

3. To connect external circulation pumps or any electromagnetic valves, firstly loose the aviation socket and dismount it as indicated below. Connect the wire to aviation socket, number 1 connects “N” wire (blue color), number 2 connects ground wire (yellow-green color), number 3 connects “L” wire (red color). Reassemble the aviation socket and connect it to the solar control system.

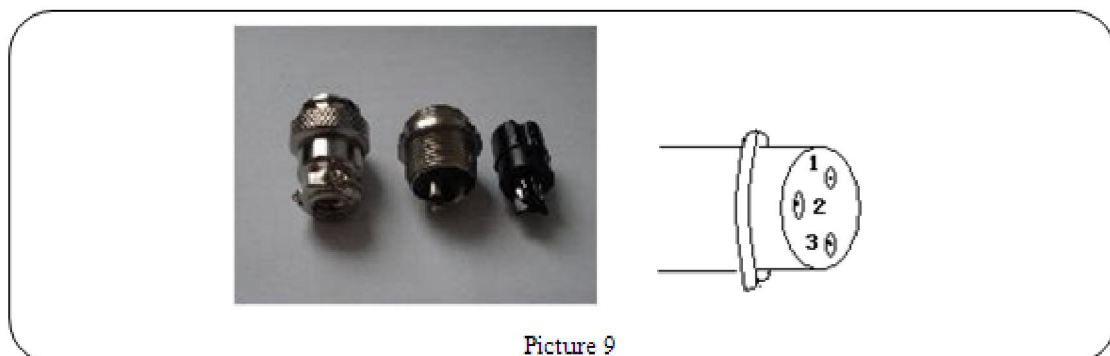

Picture 9

4. Tighten all joints and screw connections. Then plug the power supply into a socket.



## Commissioning

1. Switch on the power of solar control system. Press “Confirm” button 2 seconds (in main operating menu) to activate the solar collector pump (P1).

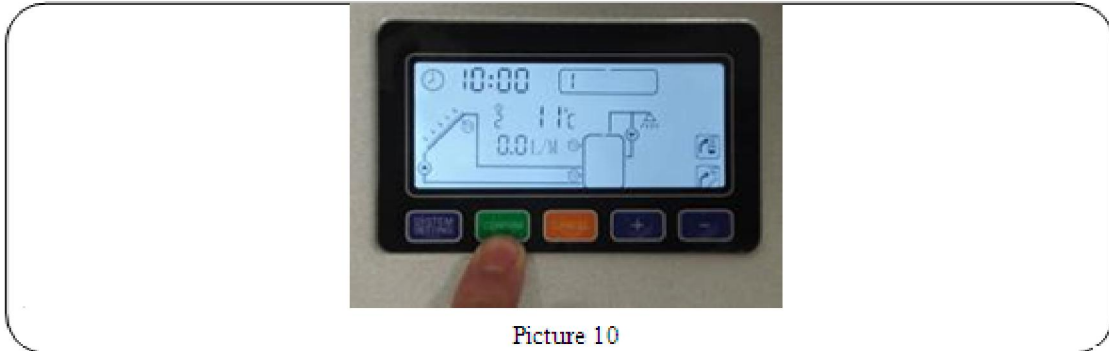

Figure 10

2. Observe the flow rate of solar control system which displays on LCD screen. If the flow rate is not regular, it indicates that there must be air still in the system. Open the air vent valve several times to relief the air.

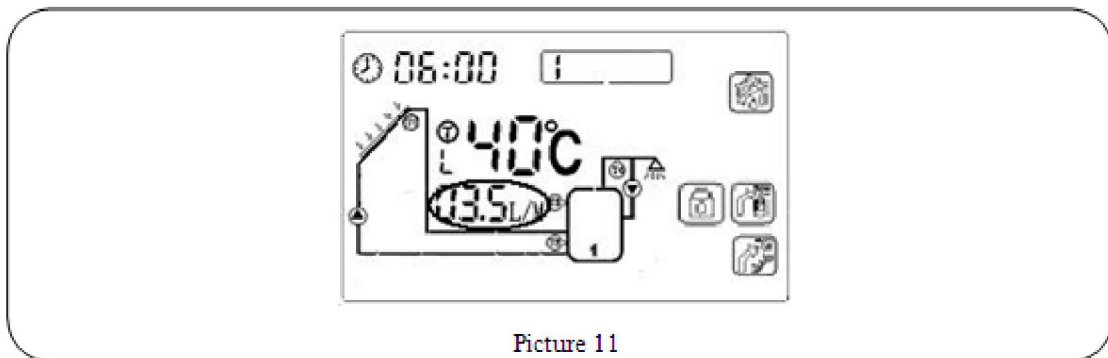

Figure 11

3. When the flow rate becomes regular, observe the system pressure from manometer. If the pressure is lower than 2 bars, refill the system with heat medium to increase the pressure.

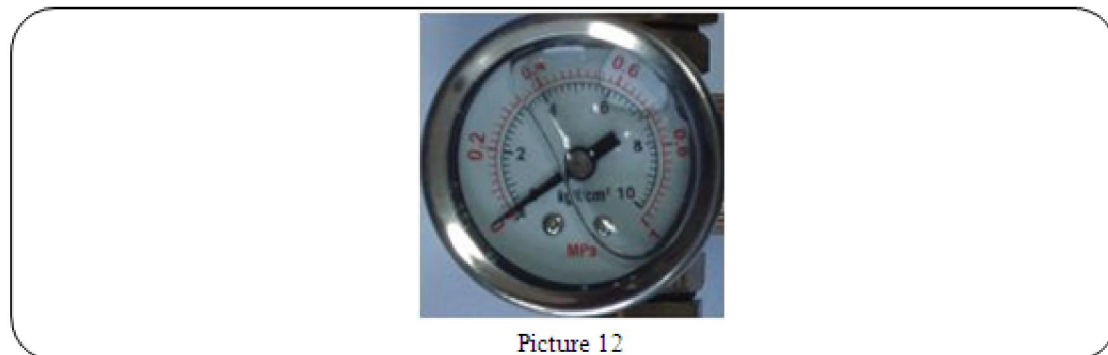



Figure 12

4. Carry out a pressure test of all system joints again for leaks. The solar system must be vented several times after some operating hours. Refill the system if necessary.
5. Remove the separate pump for filling after commissioning.
6. If there is auxiliary heating wire connected, press “Confirm” button until “” signal displays on screen. It means switch on auxiliary heating manually. Then customer can use auxiliary heating function.

## Replace the pump

1. The integrated solar collector pump could be replaced if it gets broken. Disconnect the power supply of solar control system. Loose the screw and open the metal cover.



Picture 13

2. Remove the front half of the insulation material from system



Picture 14

3. Open the terminal box, and disconnect the power supply connection.



Picture 15

4. Loose the screws and open the WILO pump.



Picture 16

5. Replace the old one with a new WILO pump.

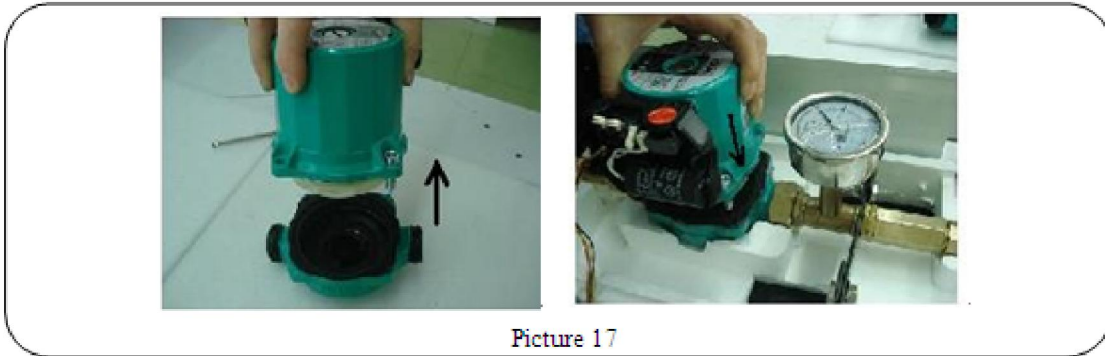

6. Fasten the WILO pump screws.



7. Connect the power supply again and close the terminal box.

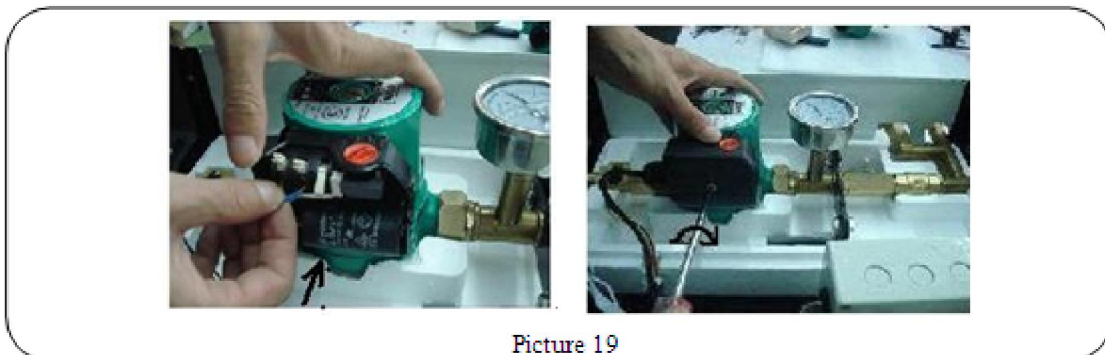

8. Attach the front half the foam cover.



9. Attach the meal cover and fasten the screws again.



Picture 21

## Packing list

No.	Item	Specification	Quantity
1	Work station	380x220x140mm	1 pc
2	Power line		1 pc
3	PT1000 sensor	15m	1 pc
4	NTC sensor	3m	2 pcs
5	Fixed screw		1 bag
6	Manual		1 pc